

survitec

# MARINE CATALOGUE

PROVIDING CRITICAL SAFETY SOLUTIONS



# OUR VALUES

1

SAFETY AND  
REDUCING RISK  
IS INTEGRAL TO  
EVERYTHING WE DO

2

WE ARE COMMITTED  
TO DELIVER REAL  
VALUE AND  
CONFIDENCE TO OUR  
CUSTOMERS

3

WE CARE FOR  
OUR PEOPLE AND  
INVEST IN THEIR  
DEVELOPMENT AS  
INDIVIDUALS AND  
TEAMS

4

WE AIM FOR  
EXCELLENCE IN  
EVERYTHING WE DO

5

WE SEEK TO  
INNOVATE AT EVERY  
OPPORTUNITY

6

INTEGRITY: WE DO  
WHAT WE SAY WE  
WILL DO

At **survitec**, the foundations of how we act as a business are based on our **values**.

We strive to embed these values of **safety, people, customers, excellence** and **innovation**, all underpinned by **integrity**, in all that we do.

# PROTECTING OVER 1 MILLION LIVES EVERY DAY

When it comes to safety, Survitec is uncompromising. We exist to ensure that you operate with the most appropriate safety and survival equipment for your people and your customers. Our values drive this behaviour each and every day.

At the heart of Survitec are our people. The collective knowledge, skills and expertise of our diverse global community, made up of best-in-class experts, are critical to fulfilling our vision to be the world's most trusted company for critical safety and survival solutions.

It is why Survitec remains the world's leading manufacturer and supplier of safety and survival solutions worldwide, at the forefront of innovation, design, and application engineering.

Our rich heritage, dating back over 160 years, has earned Survitec a reputation as a trusted safety partner for operators worldwide, consistently delivering world-class safety solutions of value. Focusing on delivering exceptional levels of safety, reliability, and compliance, that go above and beyond the industry standard.

Whether you require complete safety asset supply and management solutions or one-off product sales or services, our dedicated teams are always ready to support you to find the right solutions for your business.

## #SurvitecForLife

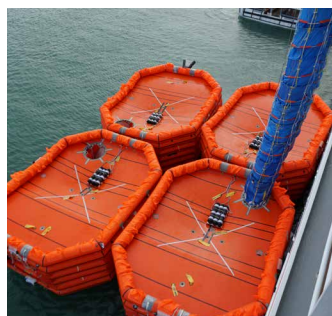

# DEDICATED GLOBAL SUPPORT

WORLD'S LARGEST SUPPLY AND SERVICE NETWORK

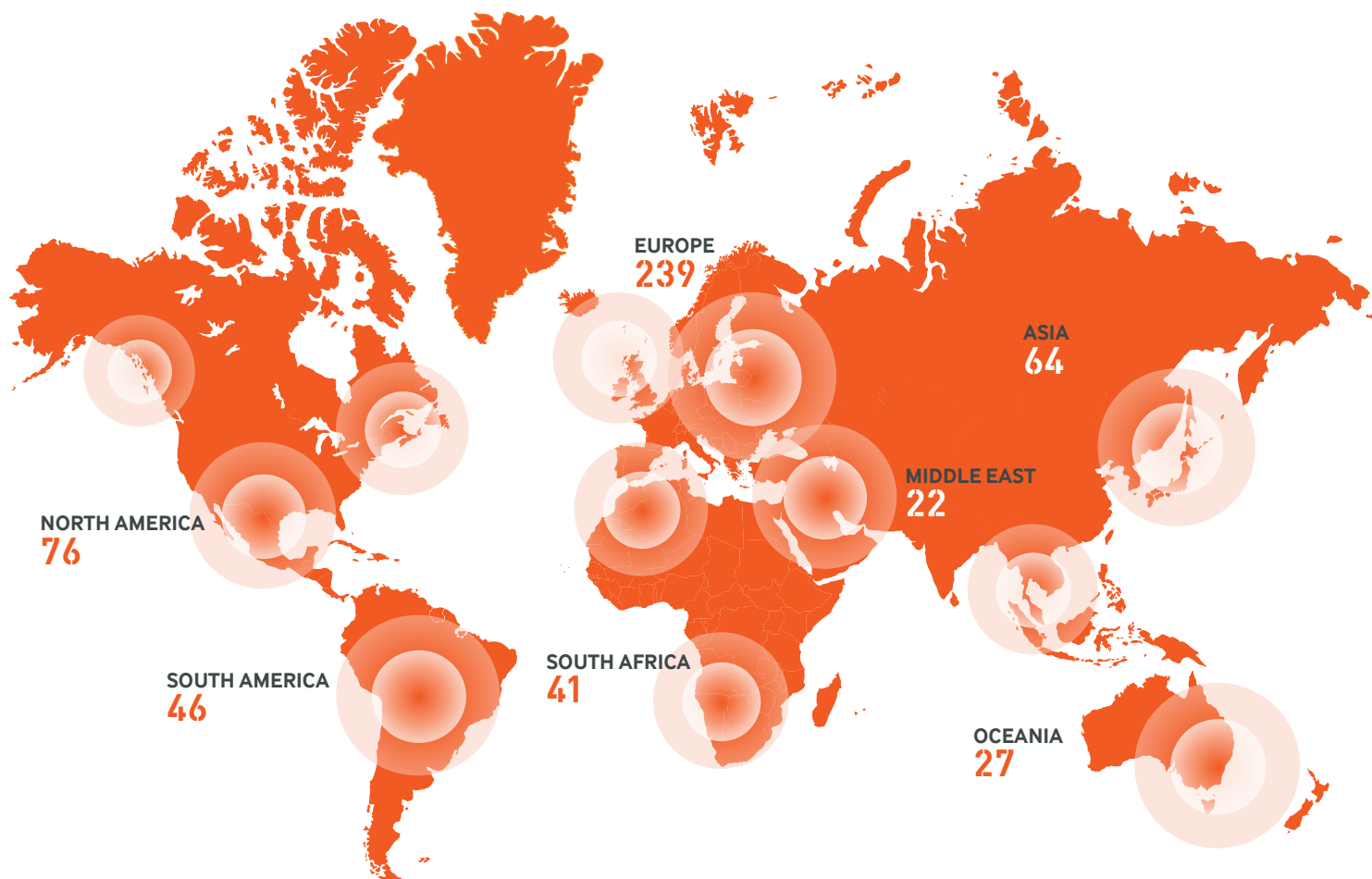

- 3000+ EMPLOYEES
- 700 TRAINED SERVICE ENGINEERS
- 8 MANUFACTURING FACILITIES
- 12 OFFSHORE SUPPORT LOCATIONS
- 70 LOCATIONS
- 410+ ACCREDITED SERVICE STATIONS
- COVERAGE AT 2,000 PORTS WORLDWIDE
- INTERNATIONAL PRESENCE IN 96 COUNTRIES
- 3 DNV-GL CERTIFIED TRAINING CENTRES



# A HISTORIC JOURNEY OF INNOVATION

With over 90 years' industry experience, Survitec is the market leader in the design and manufacture of marine safety equipment. Our mission is to continually strengthen our position as leading global supplier to the maritime industry through customer focus, product and service excellence and technical innovation.

BEAUFORT LTD  
FOUNDED



1854

ORIGINAL  
'MAE WEST' AVIATION  
LIFE PRESERVER



1940

SURVITEC ISSUES  
WORLD'S 1<sup>ST</sup>  
SUBMARINE ESCAPE  
SUIT



1952

WORLD'S 1<sup>ST</sup>  
SYNTHETIC LIFE BUOY,  
THE 'PERRY BUOY'  
INTRODUCED



1960

1932



WORLD'S 1<sup>ST</sup>  
INFLATABLE LIFERAFT  
INTRODUCED

1950



WORLD'S 1<sup>ST</sup> FASTJET  
ANTI-G TROUSERS

1959



WORLD'S 1<sup>ST</sup> SOLAS  
IMMERSION SUIT

1979



WORLD'S 1<sup>ST</sup> MARINE  
EVACUATION SYSTEM  
(MES)



**THROUGHOUT OUR 160-YEAR HISTORY,  
SURVITEC HAS REMAINED AT THE  
FOREFRONT OF INNOVATION, DESIGN  
AND APPLICATION ENGINEERING.**

**LAUNCH OF THE RFD  
MARIN ARK1**



**1999**

**1000 SERIES  
PASSENGER SUIT  
DEVELOPED USING  
NASA TECHNOLOGY**



**2010**

**FIRST OFFSHORE  
MES APPROVED**



**2014**

**SURVITEC MERGES  
WITH WILHELMSSEN  
MARITIME SERVICES  
AS SAFETY BUSINESS**



**2016**

**SURVITEC LAUNCHES  
SOLAS 360 -  
COMPLETE SAFETY  
AND COMPLIANCE  
OFFERING**



**2018**

**2001**



**SURVITEC ZODIAC  
INTRODUCES  
FIRST 150 PERSON  
LIFERAFT**

**2012**



**SURVITEC  
LAUNCHES GLOBAL  
SERVICES DIVISION**

**2015**



**OFFSHORE  
PASSENGER AND  
AIRCREW TRANSIT  
EBS - FIRST TO  
MARKET HPSTASS -  
LAUNCHED**

**2017**



**CREWSAVER  
CELEBRATES 60  
YEARS OF  
INNOVATION**

# CONTENTS

## Fire Extinction

Stored Pressure Fire Extinguishers .....	Page 8
Cartridge Fire Extinguishers .....	Page 11
Wheeled Fire Extinguishers .....	Page 17
Cabinets for Fire Equipment .....	Page 21
Fire Hoses .....	Page 24
Fittings, Couplings & Nozzles .....	Page 29
Spares & Accessories .....	Page 33
NFF XFlow Water Mist Systems .....	Page 45
NFF XFlow Wet Pipe and Deluge Systems .....	Page 46
NFF XFlow Mobile Water Monitor and Water Mist Lance .....	Page 47
Dry Chemical Powder System .....	Page 48
1230 Clean Agent System .....	Page 49
Inergen Clean Agent System .....	Page 50
High Pressure CO <sub>2</sub> System .....	Page 51
Deck Foam System .....	Page 52
High Expansion Foam System .....	Page 53
Deep Fat Cooking Fire System .....	Page 54

## Fire Protection & Detection

Personal Fire Protection .....	Page 56
Inert Gas Generator .....	Page 64
Dry Inert Gas Generators .....	Page 65
Nitrogen System .....	Page 66
Nitrogen Cylinder Central .....	Page 67
Flue Gas System .....	Page 68
AC/OX Gas Distribution System .....	Page 69
Sample Extraction Smoke Detection System .....	Page 70

## Personal Protection

Portable Gas Detection .....	Page 72
Emergency Breathing .....	Page 75
Compressed Air Breathing .....	Page 77
Breathing Air Compressors .....	Page 80
Chemical Protection .....	Page 86
Height Safety .....	Page 92
Equipment Storage .....	Page 94

## Personal Lifesaving Appliances (LSA)

Inflatable Lifejackets .....	Page 97
Foam Lifejackets .....	Page 104
Immersion Suits .....	Page 107
Accessories .....	Page 111

## Liferafts

Survitec Liferafts .....	Page 124
Liferaft Rental .....	Page 125

## Lifeboats & Rescue Boats

Lifeboat Re-hooking .....	Page 127
Lifeboats .....	Page 128
Rescue Boats .....	Page 129
Liferaft and Rescue Boat Davits .....	Page 130
Lifeboat Davits .....	Page 134
Lifeboat, Rescue Boat and Liferaft LRRS .....	Page 137
Lifeboat Accessories .....	Page 139
Lifeboat Equipment .....	Page 140
Lifeboat Inspection .....	Page 141

## Emergency Communication

Pyrotechnics .....	Page 144
Epirbs .....	Page 148
SARTs .....	Page 150
Radios .....	Page 152

## First Aid & Medical

Medical Equipment .....	Page 155
Stretchers and Waterjel .....	Page 160

## Servicing & Maintenance

Servicing & Maintenance .....	Page 161
-------------------------------	----------

\*We aim to stock all products marked in bold with an asterisks throughout this brochure at our key locations.

# FIRE EXTINCTION

**KEEPING CREW AND PASSENGERS SAFE IS  
THE NUMBER ONE PRIORITY WHILST AT SEA.**

Survitec offers a wide range of fire protection equipment, accessories and spares, including fire extinguishers, hoses, fire suppression and prevention systems, smoke detectors and appropriate storage.



**Proudly supplying fire  
safety solutions since  
1970.**



# STORED PRESSURE FIRE EXTINGUISHERS

## FOAM STORED PRESSURE

- High fire ratings
- Safe firefighting
- High quality material and finish

### Benefits

- Specially blended high performance AFFF additive enables you to fight fires quickly and efficiently ensuring damage costs are reduced to a minimum
- High firefighting capabilities meaning quicker and safer firefighting
- Long life and low maintenance costs are assured as our extinguishers are manufactured from 2 mm thick steel, shot blasted, polyester coated and with an anti-rust safety pin

### Approvals

This fire extinguisher holds Apragaz notified body EC certificate of conformity in accordance with Module B of the Maritime Equipment Directive 96/98 EC as amended (MED/3.2 Portable stored pressure fire extinguishers)

These extinguishers comply with European standard: EN 3-7



### Ordering Information

Product Number	Product Name
777836	Foam Stored Pressure Fire Extinguisher 9 L PPE9A

### Accessories

Product Number	Product Name
711416	Universal Fire Extinguisher Bracket with Strap 6 kg, 9 kg, 12 kg*

### TECHNICAL DATA

Capacity	9 L
Bracket	No
Discharge time	44 s
Test Pressure	24 bar
Working Pressure	14 bar (20 °C)
Weight Empty	5 kg
Weight Full	14 kg
Diameter	185 mm
Fire Rating	34A/ 233B
Operating Temperature Range	+5 °C to +60 °C

# CO<sub>2</sub> STORED PRESSURE

- High fire ratings
- Safe firefighting
- High quality material and finish

## Benefits

- The CO<sub>2</sub> fire extinguishers are suitable to fight fires on live electrical installations and can be used on electrical fires up to 35 kV
- High firefighting capabilities meaning quicker and safer firefighting
- Long life and low maintenance costs are assured as our extinguishers are manufactured from 2 mm thick steel, shot blasted, polyester coated and with an anti-rust safety pin



## Approvals

This fire extinguisher holds Bureau Veritas EC type examination certificate as per Module B of Directive 2014/90/EU of the European Parliament (MED/3.2 Portable fire extinguishers)

These extinguishers comply with European testing standards: EN 3-7:2004 incl. /A.1:2007, EN 3-8:2006 incl. /AC:2007, EN 3-9:2006 incl. /AC:2007 and EN 3-10:2009



## Ordering Information

Product Number	Product Name
667535	CO <sub>2</sub> Stored Pressure Extinguisher 5 kg U5C*

## Accessories

Product Number	Product Name
668111	5 kg Fire Extinguisher Bracket with Strap*

## TECHNICAL DATA

Capacity	5 kg
Bracket	No
Discharge time	12 s
Burst Disc Pressure	200 bar
Test Pressure	250 bar
Working Pressure	169.3 bar
Weight Full	14 kg
Height	930 mm
Diameter	139.7 mm
Fire Rating	89B
Operating Temperature Range	-30 °C to + 60 °C

# ABC POWDER STORED PRESSURE

- High fire ratings
- Safe firefighting
- High quality material and finish

## Benefits

- Our fire extinguishers boast high levels of mono ammonium phosphate giving you quicker firefighting capability even on electrical fires up to 35 kV
- High firefighting capabilities meaning quicker and safer firefighting
- Long life and low maintenance costs are assured as our extinguishers are manufactured from 2 mm thick steel, shot blasted, polyester coated and with an anti-rust safety pin



## Approvals

These fire extinguisher hold Apragaz notified body EC type examination certificate in accordance with Module B of the Maritime Equipment Directive 96/98 EC as amended (MED/3.2 Portable stored pressure fire extinguishers)

These extinguishers comply with European testing standards: EN 3-7



## Ordering Information

Product Number	Product Name
766995	ABC Stored Pressure Fire Extinguisher 2 kg with bracket PP2P*
671594	ABC Stored Pressure Fire Extinguisher 6 kg without bracket PP6P *
739508	ABC Stored Pressure Fire Extinguisher 9 kg without bracket PP9P
743104	ABC Stored Pressure Fire Extinguisher 12 kg without bracket PP12P

## Accessories

Product Number	Product Name
671909	6 kg Fire Extinguisher Bracket with Strap
739516	9 kg Fire Extinguisher Bracket with Strap
743112	12 kg Fire Extinguisher Bracket with Strap
756387	12 kg Fire Extinguisher Bracket with Strap 5 pack

## TECHNICAL DATA

	2 kg	6 kg	9 kg	12 kg
Capacity	2 kg	6 kg	9 kg	12 kg
Bracket	Yes	No	No	No
Minimum Discharge Range	3 m	4.5 m	4.5 m	4.5 m
Test Pressure	27 bar	24 bar	24 bar	24 bar
Working Pressure	13 bar (20 °C)	13.5 bar	13.5 bar	13.5 bar
Weight Empty	2.1 kg	3.3 kg	4.4 kg	4.8 kg
Weight Full	4.1 kg	9.4 kg	13.5 kg	16.9kg
Height	380 mm	530 mm	597 mm	630 mm
Diameter	110 mm	150 mm	180 mm	190 mm
Fire Rating	13A-89B-C	27A - 144B - C	43A-233B-C	55A-233B-C
Operating Temperature Range	-20 °C to +60 °C	-20 °C to +60 °C	-20 °C to +60 °C	-20 °C to +60 °C

# CARTRIDGE FIRE EXTINGUISHERS

## ABC POWDER CARTRIDGE

- High fire ratings
- High firefighting capability
- Safe firefighting
- High quality material and finish

### Benefits

- High levels of mono ammonium phosphate gives you quicker firefighting capability even on electrical fires up to 35 kV
- High firefighting capabilities meaning quicker and safer firefighting
- High concentrates of firefighting medium ensure quicker firefighting capability to reduce damage costs
- Integrated flow control valve at the hose end equips you with a direct and better control to fight fire
- Our higher than normal industry standard burst pressure for the cylinder and hose safeguard you when firefighting
- Long life and low maintenance costs are assured as our extinguishers are manufactured from 2 mm thick steel, shot blasted, polyester coated and with an anti-rust safety pin

### Approvals

These fire extinguishers hold Bureau Veritas EC type examination certificate as per Module B of Directive 2014/90/EU of the European Parliament (MED/3.2 Portable fire extinguishers) This fire extinguisher holds Certificate of type approval from China Classification Society

These extinguishers comply with European testing standards: EN 3-7 : 2004 (+A1:2007) and EN 3-8 : 2006 (+AC 2007) and EN 3-10 : 2009.



### Ordering Information

Product Number	Product Name
766988	ABC Cartridge Fire Extinguisher without Bracket P6P 6 kg*
766990	ABC Cartridge Fire Extinguisher without Bracket P9P 9 kg*
766994	ABC Cartridge Fire Extinguisher without Bracket P12P 12 kg*

### Accessories

Product Number	Product Name
711416	Universal Fire Extinguisher Bracket with Strap 6 kg, 9 kg, 12 kg*
668285	ABC Powder Refill 6 kg
668293	ABC Powder Refill 9 kg
668319	ABC Powder Refill 12 kg
668236	CO <sub>2</sub> Cartridge 120 g for 6 kg
668244	CO <sub>2</sub> Cartridge 160 g for 9 kg
668251	CO <sub>2</sub> Cartridge 180 g for 12 kg
669655	Fire Extinguisher Bracket Straps 5 Pack*
667584	Valve Seal for Fire Extinguisher 25 Pack
667592	Safety Pin Yellow 10 Pack
667600	Wire and Seal 90 Pack

### TECHNICAL DATA

	6 kg	9 kg	12 kg
Capacity	6 kg	9 kg	12 kg
Bracket	No	No	No
Minimum Discharge Range	4 m	4 m	4 m
Test Pressure	26 bar	26 bar	26 bar
Working Pressure	13 bar	15 bar	14.2 bar
Weight Empty	5 kg	6 kg	7.8 kg
Weight Full	11 kg	15 kg	19.8 kg
Height Including hose	500 mm	640 mm	730 mm
Diameter	180 mm	180 mm	180 mm
Fire Rating	34A/233B/C	43A/233B/C	55A/233B/C
Operating Temperature Range	-30 °C to +60 °C	-30 °C to +60 °C	-30 °C to +60 °C

# WATER CARTRIDGE

- High fire ratings
- Safe firefighting
- High quality material and finish

## Benefits

- Our water fire extinguishers have a high fire rating giving quicker firefighting capability even on electrical fires up to 35kV
- High firefighting capabilities meaning quicker and safer firefighting
- Integrated flow control valve at the hose end equips the user with a direct and better control to fight fire
- Our higher than normal, industry standard burst pressure for the cylinder and hose safeguard the user when firefighting
- Long life and low maintenance costs are assured as our extinguishers are manufactured from 2 mm thick steel, shot blasted, polyester coated and with an anti-rust safety pin

## Approvals

These fire extinguishers hold Bureau Veritas EC type examination certificate as per Module B of Directive 2014/90/EU of the European Parliament (MED/3.2 Portable fire extinguishers)

This fire extinguisher holds Certificate of type approval from China Classification Society

These extinguishers comply with European standards: EN 3-7:2004 incl. /A.1:2007, EN 3-8:2006 incl. /AC:2007 and EN 3-10:2009



## Ordering Information

Product Number	Product Name
766982	Water Cartridge Fire Extinguisher E9 9 L

## Accessories

Product Number	Product Name
711416	Universal Fire Extinguisher Bracket with Strap 6 kg, 9 kg, 12 kg*
669655	Fire Extinguisher Bracket Straps 5 Pack*
668178	CO <sub>2</sub> Cartridge 60 g for 9 L
667584	Valve Seal for Fire Extinguisher 25 Pack
667592	Safety Pin Yellow 10 Pack
667600	Wire and Seal 90 Pack

## TECHNICAL DATA

Capacity	9 L
Bracket	No
Minimum Discharge Range	4 m
Test Pressure	26 bar
Working Pressure	11.2 bar
Weight Empty	6 kg
Weight Full	15 kg
Hose Height	640 mm
Diameter	180 mm
Fire Rating	21A
Operating Temperature Range	+5 °C to +60 °C

# FOAM CARTRIDGE

- High fire ratings
- Safe firefighting
- High quality material and finish

## Benefits

- Specially blended high performance AFFF additive enables you to fight fires quickly and efficiently ensuring damage costs are reduced to a minimum.
- Our standard foam fire extinguishers have a high fire rating giving quicker firefighting capability even on electrical fires up to 35 kV
- High firefighting capabilities meaning quicker and safer firefighting
- Integrated flow control valve at the hose end equips you with a direct and better control to fight fire
- The extinguisher for polar solvents is very efficient on e.g. alcohol fires
- Our higher than normal industry standard burst pressure for the cylinder and hose safeguard you when firefighting
- Long life and low maintenance costs are assured as our extinguishers are manufactured from 2 mm thick steel, shot blasted, polyester coated and with an anti-rust safety pin



## Ordering Information

Product Number	Product Name
766984	Foam Cartridge Fire Extinguisher 9 L E9A1EV without bracket*
01310468	Foam Cartridge Fire Extinguisher 9 L Polar Solvent (Alcohol) without Bracket E9A6EVP

## Approvals

These fire extinguishers hold Bureau Veritas EC type examination certificate as per Module B of Directive 2014/90/EU of the European Parliament (MED/3.2 Portable fire extinguishers)

These extinguishers comply with European standards: EN 3-7 : 2004 (+A1:2007) and EN 3-9 : 2006 (+AC 2007) and EN 3-10 : 2009.



## Accessories

Product Number	Product Name
711416	Universal Fire Extinguisher Bracket with Strap 6 kg, 9 kg, 12 kg*
668178	CO <sub>2</sub> Cartridge 60 g 9 L
736579	Fire Extinguisher Foam Charge 90 ml for 9 L Foam
667584	Valve Seal for Extinguisher 25 Pack
669655	Fire Extinguisher Bracket Straps 5 Pack*
667592	Safety Pin Yellow 10 Pack
667600	Wire and Seal 90 Pack
02301261	Foam charge 540 ml for polar solvent (Alcohol)

## TECHNICAL DATA

Capacity	9 L	9 L polar solvent
Bracket	No	No
Minimum Discharge Range	4 m	3 m
Test Pressure	26 bar	26 bar
Working Pressure	11.2 bar	11.2 bar
Weight Empty	6 kg	7 kg
Weight Full	15 kg	16 kg
Height	640 mm	640 mm
Diameter	180 mm	180 mm
Fire Rating	27A - 233B	21A 183B + Polar solvents
Operating Temperature Range	+5 °C to +60 °C	+5°C to +60 °C

# FOAM CARTRIDGE LOW TEMPERATURE

- High fire ratings
- Safe firefighting
- High quality material and finish

## Benefits

- Special blended high-performance premix for use down to -30 °C
- Fight fires quickly and efficiently ensuring damage costs are reduced to a minimum
- The extinguishers can be used on electrical fires up to 35 kV
- Integrated flow control valve at the hose end equips you with a direct and better control to fight fire
- Our higher than normal industry standard burst pressure for the cylinder and hose safeguard you when firefighting
- Long life and low maintenance costs are assured as our extinguishers are manufactured from 2 mm thick steel, shot blasted, polyester coated and with an anti-rust safety pin

## Approvals

These fire extinguishers hold Bureau Veritas EC type examination certificate as per Module B of directive 2014/90/EU of the European Parliament (MED 3.2 Portable fire extinguishers)

These extinguishers comply with European standards: EN 3-7:2004 incl. /A.1:2007, EN 3-8:2006 incl. /AC:2007, EN 3-9:2006 incl. /AC:2007 and EN 3-10:2009



## Ordering Information

Product Number	Product Name
01310708	Foam Cartridge Low Temperature Fire Extinguisher 9 L (AL9S-30) without bracket

## Accessories

Product Number	Product Name
711416	Universal Fire Extinguisher Bracket with Strap 6 kg, 9 kg, 12 kg*
669655	Fire Extinguisher Bracket Straps 5 Pack*
667584	Valve Seal for Fire Extinguisher 25 Pack
667592	Safety Pin Yellow 10 Pack
667600	Wire and Seal 90 Pack

## TECHNICAL DATA

Capacity	9 L
Bracket	No
Minimum Discharge Range	4 m
Test Pressure	26 bar
Working Pressure	11.2 bar
Weight Empty	7 kg
Weight Full	16 kg
Hose Length	640 mm
Wheel Diameter	180 mm
Fire Rating	27A 233B
Operating Temperature Range	-30 °C to +60 °C

# POWDER CARTRIDGE METAL FIRE

- High fire ratings
- Safe firefighting
- High quality material and finish

## Benefits

- D-Powder for fighting fires in metals, such as magnesium, aluminium, zinc, calcium and sodium
- Fight fires quickly and efficiently ensuring damage costs are reduced to a minimum
- Integrated flow control valve at the hose end equips you with a direct and better control to fight fire
- Our higher than normal industry standard burst pressure for the cylinder and hose safeguard you when firefighting
- Long life and low maintenance costs are assured as our extinguishers are manufactured from 2 mm thick steel, shot blasted, polyester coated and with an anti-rust safety pin

## Approvals

Type approval according to DIN EN 3-7 : 2007 in conjunction with the requirements of DIN 3-10 : 2009



## Ordering Information

Product Number	Product Name
01701358	Powder Cartridge Metal Fire Extinguisher 9 kg (P9FaM)

## Accessories

Product Number	Product Name
711416	Universal Fire Extinguisher Bracket with Strap 6 kg, 9 kg, 12 kg*
668244	CO <sub>2</sub> Cartridge 160 g for P9FaM
669655	Fire Extinguisher Bracket Straps 5 Pack*
667584	Valve Seal for Fire Extinguisher 25 Pack
667592	Safety Pin Yellow 10 Pack
667600	Wire and Seal 90 Pack

## TECHNICAL DATA

Capacity	9 kg
Bracket	No
Minimum Discharge Range	4 m
Test Pressure	26 bar
Working Pressure	15 bar
Weight Empty	7 kg
Weight Full	16 kg
Hose Length	1100 mm
Wheel Diameter	180 mm
Fire Rating	D
Operating Temperature Range	-30 °C to +60 °C



# FAT FIRE CARTRIDGE

- A and F rated- specially designed for kitchen oil fires (Class F)
- High firefighting capability
- Safe firefighting
- High quality material and finish

## Benefits

- The fat fire extinguishers contain a high performance wet chemical designed for fat fires. In addition, it will extinguish electrical fires up to 35 k
- High firefighting capabilities meaning quicker and safer firefighting
- The integrated flow control valve at the curved hose end equips the user with a direct and better control to fight the fire
- The higher than normal, industry standard burst pressure for the cylinder and hose safeguard the user when firefighting
- Long life and low maintenance costs are assured as our extinguishers are manufactured from 2 mm thick steel, shot blasted, polyester coated and with an anti-rust safety pin



## Approvals

These fire extinguishers hold Bureau Veritas EC type examination certificate as per Module B of directive 2014/90/EU of the European Parliament (MED/3.43 Nozzles for deep fat cooking equipment fire extinguishing systems (automatic or manual type). (MED/3.2 Portable fire extinguishers)

This fire extinguishers comply with European testing Standards:



- ISO 15371 (2015)
- EN 3-7 (2004) + A1 (2007)
- EN 3-8 (2006) + AC (2007)
- EN 3-10 (2009)

## Ordering Information

Product Number	Product Name
763870	Fat Fire Cartridge Fire Extinguisher 6 L AL6F

## Accessories

Product Number	Product Name
711416	Universal Fire Extinguisher Bracket with Strap 6 kg, 9 kg, 12 kg*
668178	CO <sub>2</sub> Cartridge 60 g E9A1
667584	Valve Seal for Fire Extinguisher 25 Pack
669655	Fire Extinguisher Bracket Straps 5 Pack
667592	Safety Pin Yellow 10 Pack
667600	Wire and Seal 90 Pack

## TECHNICAL DATA

Capacity	6 L
Bracket	No
Minimum Discharge Range	3 m
Test Pressure	26 bar
Working Pressure	11.2 bar
Weight Empty	6 kg
Weight Full	12 kg
Height	500 mm
Diameter	180 mm
Fire Rating	21A 75F
Operating Temperature Range	-20 °C to +60 °C

# WHEELED FIRE EXTINGUISHERS

## WHEELED ABC POWDER CARTRIDGE

- High fire ratings
- Easy firefighting capability
- Safe firefighting
- High quality material and finish

### Benefits

- Our fire extinguishers boast high levels of mono ammonium phosphate giving you quicker firefighting capability even on electrical fires up to 35 kV
- High firefighting capabilities meaning quicker and safer firefighting
- Long and non kinking hose with opening tap equips you with a direct and better control to fight fire
- Our higher than normal, industry standard burst pressure for the cylinder and hose safeguard you when firefighting
- Long life and low maintenance costs are assured as our extinguishers are manufactured from 2 mm thick steel, shot blasted, polyester coated and with an anti-rust safety pin

### Approvals

These fire extinguishers hold Bureau Veritas EC type examination certificate as per Module B of directive 2014/90/EU of the European Parliament (MED/3.52 Non-portable and transportable fire extinguishers )

These fire extinguishers hold Certificate of type approval from China Classification Society

These extinguishers comply with European testing standards: EN 1866-1 : 2007 and EN 1866-2 : 2014



### Ordering Information

Product Number	Product Name
778991	Wheeled ABC Fire Extinguisher 25 kg SP25P*
778994	Wheeled ABC Fire Extinguisher 50 kg SP50P*

### Accessories

Product Number	Product Name
667600	Wire and Seal 90 Pack
674317	ABC Powder Refill 25 kg
668327	CO <sub>2</sub> Cartridge 450 g for 25 kg
667584	Valve Seal for Fire Extinguisher 25 Pack
667899	Safety Pin with Ring 25 kg 10 Pack
735046	CO <sub>2</sub> Cylinder 900 for SP50P/SE135A2 Head Up
667824	Cylinder valve connection Seal 25 Pack
667766	O-Ring for Top E45A2/P50/P50P 5 Pack
667683	Safety Pin 50 kg 10 Pack

### TECHNICAL DATA

Capacity	25 kg	50 kg
Bracket	No	No
Minimum Discharge Range	8 m	8 m
Test Pressure	22 bar	26 bar
Working Pressure	15 bar	16.4 bar
Weight Empty	24 kg	34.5 kg
Weight Full	49 kg	84.5 kg
Height with Handle	1000 mm	1015 mm
Width with Wheels	420 mm	450 x 500 mm
Hose Length	3.5 m	5 m
Wheel Diameter	300 mm	300 mm
Fire Rating	A-IIB-C	A-IVB-C
Operating Temperature Range	-30 °C to +60 °C	-30 °C to +60 °C

# WHEELED ABC POWDER STORED PRESSURE

- High fire ratings
- Safe firefighting
- High quality material and finish

## Benefits

- Our fire extinguishers boast high levels of mono ammonium phosphate giving quicker firefighting capability even on electrical fires up to 35 kV
- High firefighting capabilities meaning quicker and safer firefighting
- Our higher than normal, industry standard burst pressure for the cylinder and hose safeguard the user when firefighting
- Long life and low maintenance costs are assured as our extinguishers are manufactured from 2 mm thick steel, shot blasted, polyester coated and with an anti-rust safety pin



## Approvals

This fire extinguisher holds Apragaz EC type examination in accordance with Module B of Directive 2014/90/EU on marine equipment (MED/3.2 Wheeled stored pressure fire extinguishers)

These extinguishers comply with European testing standards: EN1866-1



## Ordering Information

Product Number	Product Name
755348	Powder Ext 25kg Pp25p Wheeled PP25P*

## TECHNICAL DATA

Capacity	25 kg
Bracket	No
Minimum Discharge Range	6 m
Test Pressure	27 bar
Working Pressure	15 bar
Weight Empty	17 kg
Weight Full	42.3 kg
Height	910 mm
Width with wheels:	380 mm
Fire Rating	A - IB - C
Operating Temperature Range	-20 °C to +60 °C

# WHEELED CO<sub>2</sub>

- High fire ratings
- High firefighting capability
- Safe firefighting
- High quality material and finish

## Benefits

- Long and non-kinking hose with insulated spray nozzle equips you with a direct and better control to fight fire
- High firefighting capabilities meaning quicker and safer firefighting
- Our higher than normal, industry standard burst pressure for the cylinder and hose safeguard you when firefighting
- Long life and low maintenance costs are assured as our extinguishers are manufactured from 2 mm thick steel, shot blasted, polyester coated and with an anti-rust safety pin



## Ordering Information

Product Number	Product Name
767929	Wheeled CO2 Fire Extinguisher 9 kg U9C*
767930	Wheeled CO2 Fire Extinguisher 20 kg U20C*
667568	Wheeled CO2 Fire Extinguisher 20 kg U45 MED

## Approvals

These fire extinguishers hold Bureau Veritas EC type examination certificate as per Module B of directive 2014/90/EU of the European Parliament (MED/3.52 Non-portable and transportable fire extinguishers)

This fire extinguisher holds Certificate of type approval from China Classification Society

These extinguishers comply with European testing standards: EN 1866-1 : 2007 and EN 1866-3 : 2013



## TECHNICAL DATA

Capacity	9 kg	20 kg
Bracket	No	
Minimum Discharge Range	4 m	3 m
Test Pressure	300 bar	
Working Pressure	169.3 bar	176 bar
Weight Empty	40 kg	60 kg
Weight Full	49 kg	80 kg
Dimensions in Stored Position with Handle, Length x Width x Height	1100 x 500 x 1200 mm	
Hose Length	5 m	
Wheel Diameter	300 mm	
Fire Rating	113B	183B
Operating Temperature Range	-30 °C to +60 °C	

# WHEELED FOAM CARTRIDGE

- High fire ratings
- High firefighting capability
- Safer firefighting
- High quality material and finish

## Benefits

- Specially blended high performance AFFF additive enables the user to fight fires quickly and efficiently
- High firefighting capabilities meaning quicker and safer firefighting
- Long and non-kinking hose with opening tap gives direct and better control to fight fires
- The higher than normal industry standard burst pressure for the cylinder and hose safeguard the user when firefighting
- Long life and low maintenance costs are assured as our extinguishers are manufactured from 2 mm thick steel, shot blasted, polyester coated and with an anti-rust safety pin



## Approvals

These fire extinguishers hold Bureau Veritas EC type examination certificate as per Module B of directive 2014/90/EU of the European Parliament (MED/3.52 Non-portable and transportable fire extinguishers)

These fire extinguishers hold Certificate of type approval from China Classification Society

These extinguishers comply with European standards: EN 1866-1 : 2007 and EN 1866-2 : 2014



## Ordering Information

Product Number	Product Name
778998	Wheeled Foam Fire Extinguisher 45 L SE45A2*
778996	Wheeled Foam Fire Extinguisher 135 L SE135A2*

## Accessories

Product Number	Product Name
668210	AFFF Foam Charge for 45 L
02300021	AFFF Foam Charge 2,7L for SE135A2
668194	CO2 Cylinder 450 g (45 L)
735046	CO2 Cylinder 900 g (135 L)
667683	Safety Pin 10 Pack
667600	Wire and Seal 90 Pack
667766	O-ring for top 45 L 50 kg and 135 L

## TECHNICAL DATA

Capacity	45 L	135 L
Minimum Discharge Range	6 m	6 m
Test Pressure	26 bar	26 bar
Working Pressure	16.4 bar	18.4 bar
Weight Empty	36 kg	96 kg
Weight Full	81 kg	231 kg
Dimensions in Stored Position with Handle, Length x Width x Height	1100 x 500 x 1200 mm	
Hose Length	5 m	5 m
Wheel Diameter	300 mm	400 mm
Fire Rating	A-IVB	A-IVB
Operating Temperature Range	+5 °C to +60 °C	

# CABINETS FOR FIRE EQUIPMENT

## FIRE CABINETS

- IP54 - IP56 rated
- Lloyd's Type Test approval, making the ideal for use in demanding conditions
- Cabinets are available in a range of off-the-shelf sizes
- Storage of single or double 9 kg and 12 kg fire extinguishers and single or double 5 kg CO2 extinguishers
- Manufactured in GRP or ABS (SOS101)



### Approvals

Lloyd's Type Test Approval (not including SOS101)



### Ordering Information

Product Number	Product Name
1097323	JB01 Fire Extinguisher Cabinet
FFCABJB82	JB82 Fire Extinguisher Cabinet
FFCABJB83	JB83 Fire Extinguisher Cabinet
FFCABJB65	JB65 Fire Extinguisher Cabinet
FFCABSOS101	SOS101 Fire Extinguisher Cabinet

## CABINETS FOR FIRE EXTINGUISHERS 6 KG TO 9 KG

- Window allows equipment to be checked quickly without the need to remove it from the cabinet
- You can wall, or floor mount these cabinets to suit your storage availability
- The plastic hinges and door catch give a longer life than traditional steel
- The rubber door seal gives you additional protection against moisture and dusts



### Ordering Information

Product Number	Product Name
766827	Cabinet for fire extinguisher 6 kg to 9 kg

### Accessories

TECHNICAL DATA	
Length	270 mm
Width	400 mm
Height	840 mm

PRODUCTS	
Product Number	Product Name
659201	IMO Sign Portable Extinguisher

# FIRE HOSE CABINETS

- IP56 rated
- Lloyd's Type Test approval, making the ideal for use in demanding conditions (not inclusive of SOS300)
- Cabinets are available in a range of off-the-shelf sizes
- Accommodates various lengths of fire hose and branch pipes
- Versatile fire equipment cabinets enabling the storage of fire hoses alongside other firefighting equipment



## Approvals

Lloyd's Type Test Approval (not including SOS101)



## Ordering Information

Product Number	Product Name
FFCABSOS300	SOS300 Fire Hose Cabinet
FFCABJB02H	JB02H Fire Hose Cabinet
FFCABJB14H	JB14H Fire Hose Cabinet

# FOAM STATION BOX SOS505

- Stainless steel hinges and fittings
- Waterproof
- Clear labelling

## Benefits

- We offer a large capacity, so you can stow multiple products if required
- Our manufacturing process and stainless-steel fittings give strong colour fastness for a longer life
- Options include floor or wall mounted versions enabling you to maximise your space
- For total protection of your equipment you can choose internal fittings to be included



## TECHNICAL DATA

Height x width x depth	460 x 980 x 620 mm
Weight	19 kg
IP Rating	IPX5
Colour	Red
Material	4-5 mm UV Stabilised rationally molded polyethelene
Door catch	Marine specification bungy cord for fast access
Hinges	Stainless Steel
Optional Extras	Lettering

## Ordering Information

Product Number	Product Name
1097086	Foam Station Box, PE SOS505

# CABINETS FOR HELIDECK FIRE HOSES

- GRP
- Stainless steel hinges and fittings
- Waterproof
- Clear labelling

## Benefits

- We offer a large capacity so you can stow multiple products if required
- Our manufacturing process and stainless-steel fitting give strong colour fastness for a longer life
- Options include floor or wall mounted versions enabling you to maximise your space
- For total protection of your equipment you can choose internal fittings to be included



## Ordering Information

Product Number	Product Name
546689	Cabinet for Helideck Fire Hose





# FIRE HOSES

## MERTEX FIRE HOSES

- Rugged inner and external lining
- Light-weight and extreme low temperature

### Benefits

- Our hose is manufactured as circular woven with inner thermoplastic polyurethane lining safeguarding it against both internal and external wear
- Light-weight design enables carrying them with ease on board a vessel when fighting fires
- Our hoses are fitted with Storz or Norwegian couplings providing a ready to use hose compatible with the vessel's fire equipment. Please note some hoses can be supplied without couplings
- Our hoses use materials that safeguards the hoses against external damage from UV radiation and oil or commonly used chemicals



### Approvals

SOLAS 74 Convention as amended, Regulation II-2/10,X/3, IMO Res. MSC.36(63)-(1994 HSC Code) as amended, 7, IMO Res. MSC.97(73)-(2000 HSC Code) as amended, 7, EN 14540:2014



### Ordering Information

Product Number	Product Name
589564	Mertex Fire Hose 2.5 inch per m without Coupling
<b>589572</b>	<b>Mertex Fire Hose 2 inch per m without Coupling*</b>
<b>589648</b>	<b>Mertex Fire Hose 2 inch, 15 m including Storz C Coupling*</b>
758870	Mertex Fire Hose 2 inch, 18 m including Storz C Coupling
<b>758862</b>	<b>Mertex Fire Hose 2 inch, 20 m including Storz C Coupling*</b>
589671	Mertex Fire Hose 2.5 inch, 15 m including Storz 65 Coupling

### Accessories

Product Number	Product Name
60521	Portable Binding Machine
605220	Clamping Device for Binding Machine
758888	Binding Wire 1.6 mm (1 kg Roll)
605279	Cabinet for 20 m Fire Hose

#### MERTEX FIRE HOSE 2.5 INCH PER M WITHOUT COUPLING

##### TECHNICAL DATA

Length	Per M
Inner Diameter	2 1/2 inch/64.5 mm
Weight	0.35 kg/0.23 lbs
Max Working Pressure	15 bar
Minimum Burst Pressure	50 bar
Operating Temperature Range	-50 °C to +75 °C

#### MERTEX FIRE HOSE 2 INCH PER M WITHOUT COUPLING

##### TECHNICAL DATA

Length	Per M
Inner Diameter	2 inch/51.5 mm
Weight	0.27 kg/m or 0.18 lbs/ft
Max Working Pressure	15 bar
Minimum Burst Pressure	50 bar
Operating Temperature Range	-50 °C to +75 °C

**MERTEX FIRE HOSE 2 INCH 15M INCLUDING STORZ C COUPLING**

**TECHNICAL DATA**

Length	15 M
Inner Diameter	2 inch/51.5 mm
Weight	4.05 kg/m or 2.7 lbs/ft
Max Working Pressure	15 bar
Minimum Burst Pressure	50 bar
Operating Temperature Range	-50 °C to +75 °C
<b>Coupling</b>	
Nominal Size	52=C
Lug Spacing	66 mm
Weight	0.970 kg
Length Tail Piece	75 mm
Inside Diameter	45 mm

**MERTEX FIRE HOSE 2 INCH, 18 M INCLUDING STORZ C COUPLING**

**TECHNICAL DATA**

Length	18 M
Inner Diameter	2 inch/51.5 mm
Weight	4.86 kg/3.24 lbs
Max Working Pressure	15 bar
Minimum Burst Pressure	50 bar
Operating Temperature Range	-50 °C to +75 °C
<b>Coupling</b>	
Nominal Size	52=C
Lug Spacing	66 mm
Weight	0.970 kg
Length Tail Piece	75 mm
Inside Diameter	45 mm

**MERTEX FIRE HOSE 2 INCH , 20 M INCLUDING STORZ C COUPLING**

**TECHNICAL DATA**

Length	20 M
Inner Diameter	2 inch/51.5 mm
Weight	5.4 kg/3.6 lbs
Max Working Pressure	15 bar
Minimum Burst Pressure	50 bar
Operating Temperature Range	-50 °C to +75 °C
<b>Coupling</b>	
Nominal Size	52=C
Lug Spacing	66 mm
Weight	0.970 kg
Length Tail Piece	75 mm
Inside Diameter	45 mm

**MERTEX FIRE HOSE 2.5 INCH, 15 M INCLUDING STORZ 65 COUPLING**

**TECHNICAL DATA**

Length	15 M
Inner Diameter	2 1/2 inch/64.5 mm
Weight	5.25 kg/3.45 lbs
Max Working Pressure	15 bar
Minimum Burst Pressure	50 bar
Operating Temperature Range	-50 °C to +75 °C
<b>Coupling</b>	
Nominal Size	65=DS
Lug Spacing	81 mm
Weight	1.45 kg
Length Tail Piece	100 mm
Inside Diameter	55 mm



# GUARDMAN FIRE HOSES

- Rugged woven polyester design
- Light-weight
- Fitted with Storz or Norwegian couplings

## Benefits

- Our hose is made of rubber blend with a circular woven polyester jacket giving safer usage operations by absorbing sudden pressure increase during use
- Light-weight design enables carrying them with ease on board a vessel when fighting fires
- Our hoses are fitted with either Storz or Norwegian standard coupling ready for vessel use. The hoses are made of materials that safeguards the hoses against external damage from UV radiation and oil or commonly used chemicals



## Approvals

SOLAS 74 Convention as amended, Regulation II-2/10,X/3, IMO Res. MSC.36(63)-(1994) HSC Code) as amended, 7, IMO Res. MSC.97(73)-(2000 HSC Code) as amended, 7, EN 14540:2014

### 1 1/2 INCH, 15 M INCLUDING STORZ C COUPLING

#### TECHNICAL DATA

Length	15 m
Inner Diameter	1 1/2 inch / 38 mm
Wall Thickness	0.09 inch/2.2 mm
Weight	5.7 kg/3.75 lbs
Max Working Pressure	15 bar
Minimum Burst Pressure	45 bar
Operating Temperature Range	-30 °C to +75 °C

#### Coupling

Coupling Size	52=C
Lug Spacing	66 mm
Weight	0.970 kg

### 2 INCH PER M WITHOUT COUPLINGS

#### TECHNICAL DATA

Length	Minimum 1 m - Max 1000 m
Inner Diameter	2 inch/51 mm
Wall Thickness	0.09 inch/2.2 mm
Weight	0.38 kg/m or 0.25 lbs/ft
Max Working Pressure	15 bar
Minimum Burst Pressure	45 bar
Operating Temperature Range	-30 °C to +75 °C

## Ordering Information

Product Number	Product Name
510701	Guardman Fire Hose 2 inch, 15 m with Nor-1 Coupling
<b>574947</b>	<b>Guardman Fire Hose 2 inch per m without Coupling*</b>
<b>574954</b>	<b>Guardman Fire Hose 2.5 inch per m without Coupling*</b>
510719	Guardman Fire Hose 2 inch, 15 m including Nor-2 Coupling
589598	Guardman Fire Hose 1 1/2 inch, 15 m including Storz C Coupling
<b>510727</b>	<b>Guardman Fire Hose 2 inch, 15 m including Storz C Coupling*</b>
589614	Guardman Fire Hose 2.5 inch, 15 m including Storz-65 Coupling
233759	Guardman Fire Hose 1.5 inch, 15m without Coupling
<b>574939</b>	<b>Guardman Fire Hose 1.5 inch per m without Coupling*</b>
233767	Guardman Fire Hose 2 inch, 15 m without Coupling
233775	Guardman Fire Hose 2 inch, 15 m without Coupling

## Accessories

Product Number	Product Name
605212	Portable Binding Machine
605220	Clamping Device for Binding Machine
758888	Binding Wire 1.6 mm (1 kg Roll)
605279	Cabinet for 20 m Fire Hose

### GUARDMAN FIRE HOSE 1 1/2 INCH WITHOUT COUPLING

#### TECHNICAL DATA

Length	Minimum 1 m - Max 2000 m
Inner Diameter	1 1/2 inch/38 mm
Wall Thickness	0.09 inch/2.2 mm
Weight	0.3 kg/m or 0.2 lbs/ft
Max Working Pressure	15 bar
Minimum Burst Pressure	50 bar
Operating Temperature Range	-30 °C to +75 °C

**2 INCH, 15 M INCLUDING STORZ C COUPLING**

**TECHNICAL DATA**

Length	15 m
Inner Diameter	2 inch/51.5 mm
Wall Thickness	0.09 inch/2.2 mm
Weight	5.7 kg/3.75 lbs
Max Working Pressure	15 bar
Minimum Burst Pressure	45 bar
Operating Temperature Range	-30 °C to +75 °C
<b>Coupling</b>	
Coupling Size	52=C
Lug Spacing	66 mm
Weight	0.970 kg

**2 1/2 INCH, 15 M COMPLETE WITH STORZ-65 COUPLING**

**TECHNICAL DATA**

Length	15 m
Inner Diameter	2 1/2 inch / 65 mm
Wall Thickness	0.09 inch/2.2 mm
Weight	7.95 kg / 5.25 lbs
Max Working Pressure	15 bar
Minimum Burst Pressure	45 bar
Operating Temperature Range	-30 °C to +75 °C
<b>Coupling</b>	
Coupling Size	65=DS
Lug Spacing	81 mm
Weight	1.45 kg

**2 1/2 INCH PER M WITHOUT COUPLINGS**

**TECHNICAL DATA**

Length	Minimum 1 m - Max 2000 m
Inner Diameter	2 1/2 inch / 65 mm
Wall Thickness	0.09 inch/2.2 mm
Weight	0.53 kg/m or 0.35 lbs/ft
Max Working Pressure	15 bar
Minimum Burst Pressure	45 bar
Operating Temperature Range	-30 °C to +75 °C

# PORTABLE BINDING MACHINE

- Strong hand crank
- Cast construction
- Hand crank allows you to optimally adapt the clamping arrangement to the coupling size.
- The clamping device can be easily fixed to any standard vice in a vessel's workshop with a jaw of a least 75 mm



**TECHNICAL DATA**

Coupling size	Number of coils (Minimum)
110 mm	10
75 mm	4
52 mm	3
25 mm	3

**Accessories**

Product Number	Product Name
605220	Clamping Device for Binding Machine*

**Ordering Information**

Product Number	Product Name
605212	Portable Binding Machine

**Spare**

Product Number	Product Name
758888	Binding Wire 1.6 mm

# FIRE BLANKET

- Manufactured by two layers of woven glass fibre fabric with inner layer of fire retardant film
- Handles that are external from the inner casing are made of blue fire-retardant cotton webbing
- Lightweight and compact size meaning ease of storage on board your vessel



## TECHNICAL DATA

<b>Blanket material</b>	JT 510 3-ply - two layers of woven glass fibre fabric with inner layer of fire-retardant film
<b>Handle material</b>	Flame retardant cotton webbing - Blue
<b>Weight</b>	530 g/m <sup>2</sup> (nominal)
<b>Sizes available (mm)</b>	1.1 x 1.1 m / 204 x 178 x 50 mm 1.2 x 1.2 m / 254 x 178 x 50 mm 1.8 x 1.1 m / 337 x 184 x 55 mm 1.8 x 1.2 m / 337 x 184 x 55 mm
<b>Holders Available Colours</b>	Jacpack Premium Range - Red or White Flexible pack – Red only
<b>Certification</b>	BSI Certified to BS EN1869: 1997 Kitemark Licence No KM 25047 L.P.C.B Tested BAFE Approved
<b>Guarantee</b>	5 years (blanket) - Recommended replacement after 5 Years
<b>Performance</b>	Cooking oil fire 3 L (see BS EN1869: 1997)
<b>Other Information</b>	Discard if any evidence of damage Discard blanket after use Blanket should be withdrawn from holder every 12 months, unfolded and checked for the following: - - Damage or discolouration of the surface - Handle fixing

## Ordering Information

### PRODUCTS

Product Number	Product Name
FFBLKT1.1X1.1	Fire Blanket 1.1M x 1.1M
FFBLKT1.2X1.2	Fire Blanket 1.2M x 1.2M
FFBLKT1.8X1.1	Fire Blanket 1.8M x 1.1M
<b>FFBLKT1.8X1.2</b>	<b>Fire Blanket 1.8M x 1.2M*</b>

## APPROVALS

BSI Certified to BS EN1869: 1997

# FITTINGS, COUPLINGS & NOZZLES

## NOR-1 & 2 COUPLINGS

- Symmetrical quick connection
- Brass alloys fitting

### Benefits

- Easy to connect quickly to the firefighting systems
- Brass alloy makes this coupling corrosion proof and maintenance-free

The below lists examples of the range.

In addition to listed, other couplings can be sourced as required.



### Ordering Information

Product Number	Product Name
233908	Nor-1 Coupling with 2 Inch Female Thread
790593	Nor-1 Coupling with 2 1/2 Inch Female Thread
233940	Nor-1 Coupling with 2 Inch Male Thread

### Ordering Information

Product Number	Product Name
233882	Nor-2 Coupling with 1 1/2 Inch Hose Socket
233841	Nor-2 Coupling with 2 Inch Hose Socket
233916	Nor-2 Coupling with 2 Inch Female Thread
233957	Nor-2 Coupling with 2 Inch Male Thread

### Accessories

Product Number	Product Name
527697	Nor Coupling Spanner

### TECHNICAL DATA

Nor-1	2 inch Female Thread	2 1/2 inch Female Thread	2 inch Male Thread
<b>Nominal Size</b>	2 inch	2 1/2 inch	2 inch
<b>Lug Spacing</b>	83 mm	83 mm	83 mm
<b>Thread</b>	G2	G2 1/2	G2 A
<b>Weight</b>	1.835 kg	1.85 kg	1.60 kg

### TECHNICAL DATA

Nor-2	1 1/2 inch Hose Socket	2 inch Hose Socket	2 inch Female Thread	2 inch Male Thread
<b>Nominal Size</b>	1 1/2 inch	2 inch	2 inch	2 inch
<b>Lug Spacing</b>	50 mm	66 mm	66 mm	66 mm
<b>Thread</b>	N/A	N/A	G2	G2 A
<b>Weight</b>	N/A	1 kg	1.20 kg	1.60 kg

# STORZ C & 65 COUPLINGS

- Symmetrical quick connection
- Brass alloy fitting

## Benefits

- Easy to connect quickly to the firefighting systems
- Brass alloy makes this coupling corrosion proof and maintenance-free



## Ordering Information

Product Number	Product Name
233858	Storz C Coupling including 2 inch Hose Socket*
605121	Storz C Coupling including 1.5 inch Male Thread
233965	Storz C Coupling including 2 inch Male Thread*
607965	Storz C Coupling including 2.5 inch Female Thread
233924	Storz C Coupling including 2 inch Female Thread*
233890	Storz C Coupling including 1.5 inch Hose Socket*

## Accessories

Product Number	Product Name
527705	Storz Coupling Spanner F, B and C Type
523357	Gasket for Storz C Coupling Lug Size 66 mm
L29627	Storz C Coupling with 1 1/4" Hose Socket
527663	Storz C Blanking Cap*

## Ordering Information

Product Number	Product Name
523431	Storz 65 Coupling with 2 inch Hose Socket
523456	Storz 65 Coupling with 2 inch Female Thread
595777	Storz 65 Coupling with 2 inch Male Thread
523449	Storz 65 Coupling with 2.5 inch Hose Socket
605311	Storz 65 Coupling with 2.5 inch Female Thread

## Accessories

Product Number	Product Name
527705	Storz Coupling Spanner F, B and C Type
523357	Gasket for Storz C Coupling Lug Size 66 mm

## TECHNICAL DATA

Storz C	2 inch HS Socket	1 1/2 inch Male Thread	2 inch Male Thread	2 1/2 inch Female Thread	2 inch Female Thread	1 1/2 inch Hose Socket
Nominal Size	2 inch	1 1/2 inch	2 inch	2 1/2 inch	2 inch	1 1/2 inch
Lug Spacing	66 mm	66 mm	66 mm	66 mm	66 mm	66 mm
Hose Diameter	52 mm	N/A	N/A	N/A	N/A	38 mm
Inside Diameter	45 mm	38 mm	45 mm	44 mm	44 mm	32 mm
Length Tail Piece	75 mm	N/A	N/A	N/A	N/A	90 mm
Face to Face Length	N/A	32 mm	32 mm	40 mm	37 mm	N/A
Thread	N/A	G 1 1/2 A	G 2 A	G 2	G 2 1/2	N/A
Weight	0.97 kg	0.6 kg	0.56 kg	0.795 kg	0.80 kg	1.135 kg

## TECHNICAL DATA

Storz 65	2 inch Hose Socket	2 inch Female Thread	2 inch Male Thread	2 1/2 inch Hose Socket	2 1/2 inch Female Thread
Nominal Size	2 inch	2 inch	2 inch	2 1/2 inch	2 1/2 inch
Lug Spacing	81 mm	66 mm	66 mm	66 mm	66 mm
Hose Diameter	52 mm	N/A	N/A	N/A	N/A
Inside Diameter	45 mm	38 mm	45 mm	44 mm	44 mm
Length Tail Piece	75 mm	N/A	N/A	N/A	N/A
Face to Face Length	N/A	32 mm	32 mm	40 mm	37 mm
Thread	N/A	G 1 1/2 A	G 2 A	G 2	G 2 1/2
Weight	0.97 kg	0.6 kg	0.56 kg	0.795 kg	0.80 kg

# SPRAY/JET NOZZLE

- Low pressure loss
- Light weight
- High impact strength

## Benefits

- Our nozzles are designed with smooth inner surfaces minimising the water pressure loss and enhancing the cooling effect
- Light weight construction allows the user to carry with ease on board a vessel when fighting fires
- Use of tough materials makes the nozzle resistant to impact and rough use helping to ensure a maintenance free long life nozzle



## Approvals

The Spray/Jet Nozzles are MED approved 2014/90/e3 MEDB 00001W2

Tests carried out to EN-15182 -1, En-15182-2 6 EN-15182-3.



## Ordering Information

Product Number	Product Name
708271	Spray/Jet Nozzle 12 mm HS-12 349 x 98 mm*
708289	Spray/Jet Nozzle 16 mm HS-16 347 x 98 mm*
708297	Spray/Jet Nozzle 20 mm HS-12 348 x 98 mm*

## TECHNICAL DATA

	Jet Mode at 2 bar pressure	Jet Mode at 6 bar pressure	Jet Mode at 8 bar pressure	Spray Mode at 2 bar pressure (120°)	Spray Mode at 6 bar pressure (120°)	Spray Mode at 8 bar pressure (120°)
<b>12 mm HS-12 349 x 98 mm</b>						
<b>Flow Rate</b>	130 L/min	230 L/min	280 L/min	265 L/min	460 L/min	575 L/min
<b>Throw Length</b>	17 m	28 m	32 m	4.5 m	4.5 m	15 m
<b>16 mm HS-16 347 x 98 mm</b>						
<b>Flow Rate</b>	170 L/min	330 L/min	410 L/min	275 L/min	470 L/min	620 L/min
<b>Throw Length</b>	18 m	30 m	34 m	4.5 m	4.5 m	16 m
<b>20 mm HS-12 348 x 98 mm</b>						
<b>Flow Rate</b>	220 L/min	380 L/min	510 L/min	275 L/min	470 L/min	670 L/min
<b>Throw Length</b>	21 m	32 m	36 m	4.5 m	4.5 m	17 m



# TURBO NOZZLE 2000

- High extinguishing effect
- Safe to use on electrical equipment fires
- Unique gun shape handle design

## Benefits

- Unique fast rotating turbo wheel atomizes the water droplets giving optimal droplet size and distribution that gives faster cooling effect when fighting fires
- The users safety is ensured when fighting electrical fires up to 30 kV as in full jet mode the max volume of water delivered prevents flash over
- The handle design gives the user a better control for operating the nozzle making it easier to fight fires in a vessel's workshop with a jaw of a least 75 mm



## Ordering Information

Product Number	Product Name
737759	Turbo Nozzle 2000 with 2 Inch Male Thread*

## Directions For Use

The pre-selected flow rate can be used by turning one of the knurled adjustment collars: 60 – 130 - 235 L/min at 6 bar. The position 130 L/min is marked by an additional button (pointer) and is located on top; at the small flow rate to the right (3 o'clock position); at the great flow rate to the left (9 o'clock position). By turning the red head of the nozzle/jet form sleeve the typo of flow can be switched from full to spray jet. The pointer on the form sleeve is at an angle of approximately 45 degrees from the tog when it is set to spray jet. By turning the jet form sleeve anti-clockwise it is switched to the maximum spray jet of 120 degrees. By turning the jet form sleeve clockwise the jet becomes a full jet. Thus the pointer is in position 11 o'clock resp. 2 o'clock.

## Approvals

The Spray/Jet Nozzles are MED approved 2014/90/e3  
Tests carried out to EN-15182 -1, En-15182-2 6  
EN-15182-3



## TECHNICAL DATA

Flow Rate at 6 bar	60-130-235 L/min
Throw Distance	20-27-31 M
Spray Angle	0 - 120 Degrees
Inlet Connection Thread	2 Inch Male Thread
Electrical Fire Application	Minimum Distance 5 M



# SPARES & ACCESSORIES

## CO<sub>2</sub> FIRE EXTINGUISHER CARTRIDGES

- Easy to replace
- High quality material and finish

### Benefits

- You can easily replace them by disconnecting the connections on the cylinder
- Coated with zinc primer our cartridges have long shelf life and require minimal space for storage on your vessel in a vessel's workshop with a jaw of a least 75 mm



### Accessories

Product Number	Product Name
766977	O Ring for P9FM.M 5 Pack
667824	Cylinder valve Connection Seal 25 Pack
756411	Valve Seal for PP6P/PP9P/PP12P/ PP25P 10 Pack
667584	Valve Seal for Fire Extinguisher 25 Pack
03123461	O-Ring 10 Pack
667766	O-Ring for Top E45A2/P50/P50P 5 Pack
667592	Safety Pin Yellow 10 Pack
667600	Wire and Seal 90 Pack
667899	Safety Pin with Ring For 25 Kg 10 Pack
667683	Safety Pin 50 kg 10 Pack

### Ordering Information

Product Number	Product Name
668178	Extinguisher Cartridge 60 g for 9 L Water/ 9 L Foam
668194	Extinguisher Cartridge 450 g for 45 L Foam
668202	Extinguisher Cartridge 2 kg for 135 L Foam
668236	Extinguisher Cartridge 120 g for 6 kg Powder
668244	Extinguisher Cartridge 160 g for 6 kg Powder
668251	Extinguisher Cartridge 180 g for 12 kg Powder
668327	Extinguisher Cartridge 450 g for 25 kg Powder
735046	CO2 Cylinder 900 g for SP50P/SE135A2 Head Up

## FIRE EXTINGUISHER FOAM CHARGES

- High performance fluoro additive
- Easy to dose and store

### Benefits

- High performance fluoro additive offers higher fire ratings. strong wetting power, impregnable film that extinguisher fire quickly
- The foam premix comes in small plastic bottles and is easy to store and replace on board your vessel



### Ordering Information

Product Number	Product Name
736579	Extinguisher Foam Charge 90 ml for 9 L Foam
668228	Extinguisher Foam Charge 3 x 0.9 L for 135 L Foam
668210	Extinguisher Foam Charge 0.9 L for 45 L Foam
02301261	Foam Charge 540 ml for Polar Solvent
02302161	Premix RC50 Wet Chemical for 6 kg Fat Fire Extinguisher

# FIRE EXTINGUISHER ABC POWDER REFILLS

- High fire rating
- Easy to store

## Benefits

- Our fire extinguishers boast high levels of mono ammonium phosphate giving you quicker firefighting capability even on electrical fires up to 35 kV
- Our powder charges come in vacuum sealed packages offering long shelf life and can be easily stored on board your vessel



TECHNICAL DATA	
Size	6, 9, 12 and 25 kg
Colour	Light blue
Apparent Density	850 - 950 kg/m <sup>3</sup>
Water content	< 0.25%

## Ordering Information

Product Number	Product Name
668285	ABC Powder Refill 6 kg
668293	ABC Powder Refill 9 kg
668319	ABC Powder Refill 12 kg
674317	ABC Powder Refill 25 kg

# MARINE BRACKETS FOR PORTABLE FIRE EXTINGUISHERS

- Robust design
- Adjustable strap

## Benefits

- Our marine brackets are manufactured with quality steel and coated with primer offering a long service life
- Adjustable straps give the flexibility to adjust and secure the extinguisher properly



## Ordering Information

Product Number	Product Name
668111	5 kg Fire Extinguisher Bracket with Strap*
671909	6 kg Stored Pressure Fire Extinguisher with Strap
739516	9 kg Stored Pressure Fire Extinguisher with Strap
743112	12 kg Stored Pressure Fire Extinguisher with Strap
711416	Universal Fire Extinguisher Bracket with Strap 6 kg, 9 kg, 12 kg*
669655	Fire Extinguisher Bracket Straps 5 Pack *

# NOR COUPLING SPANNER

Survitec's universal coupling spanner for use with Norwegian couplings - the design and composition of this spanner makes it easy to use and light weight.



## Ordering Information

Product Number	Product Name
527697	Nor Coupling Spanner

# STORZ COUPLING SPANNER

Survitec's universal coupling spanner for Storz C, 65 and B connection - the design and composition of this spanner makes it easy and light weight to use.



- Suitable for all Storz connections

## Ordering Information

Product Number	Product Name
527705	Storz Coupling Spanner for B,C and 65 Type

# GASKET FOR STORZ C COUPLINGS

- Symmetrical quick connection
- No female and male part
- Aluminium alloys fitting

## Benefits

- Easy to connect quickly to the hose ends
- No male and female threads
- Can be easily fitted to fire hoses including our range of Guardman & Mertex hoses
- Aluminium alloy makes this socket corrosion proof and maintenance-free



## TECHNICAL DATA

Nominal Size	65
Lug Spacing	66 mm
Hose Inner Diameter	52 mm
Length Tail Piece	90 mm
Inside Diameter	45 mm
Weight	1.38 kg

## Ordering Information

Product Number	Product Name
523357	Gasket for Storz C Coupling lug size 66 mm

# FOAM APPLICATORS

- Stainless steel and brass body
- Light weight
- Induction capacity up to 6 %
- Large area coverage

## Benefits

- Materials give a long-lasting life with the added benefit of being lightweight
- 3 and 6 bar options
- Design ensures your challenge is met quickly and efficiently with wide coverage range

Proportioning will work with most major foam mixes  
Suitable for both Newtonian and non-Newtonian pseudoplastic and thixotropic Foams



## TECHNICAL DATA

	Capacity	Coupling Size	Proportioning	Inductor Length
Foam Applicator 200 Litres per Minute at 3 Bar	200 Litres per Minute	2 inch BSP Female	N/A	N/A
Foam Applicator 400 Litres per Minute at 3 Bar	400 Litres per Minute	2 inch BSP Female	N/A	N/A
Foam Applicator 200 Litres per Minute at 6 Bar	200 Litres per Minute	2 inch BSP Female	N/A	N/A
Foam Applicator 400 Litres per Minute at 6 Bar	400 Litres per Minute	2 inch BSP Female	N/A	N/A
Foam Applicator 3% 200 Litres per Minute at 6 Bar	200 Litres per Minute	2 inch BSP Female	3%	1.5 M
Foam Applicator 3% 400 Litres per Minute at 6 Bar	400 Litres per Minute	2 inch BSP Female	3%	1.5 M
Foam Applicator 6% 200 Litres per Minute at 6 Bar	200 Litres per Minute	2 inch BSP Female	6%	1.5 M
Foam Applicator 6% 400 Litres per Minute at 6 Bar	400 Litres per Minute	2 inch BSP Female	6%	1.5 M

## Ordering Information

Product Number	Product Name
740605	Foam Applicator 200 L/min at 3 bar
740621	Foam Applicator 400 L/min at 3 bar
740613	Foam Applicator 200 L/min at 6 bar
740639	Foam Applicator 400 L/min at 6 bar
740647	Foam Applicator-S 3 % 200 L/min at 6 bar
740662	Foam Applicator-S 3 % 400 L/min at 6 bar
740654	Foam Applicator-S 6 % 200 L/min at 6 bar
740670	Foam Applicator-S 6 % 400 L/min at 6 bar

## Accessories

Product Number	Product Name
1097086	Foam Station Box
<b>233965</b>	<b>Storz C Couplings 2" Male Connection*</b>
595777	Storz 65mm Male Connection
233940	NOR-1 Coupling 2" Male Connection
233957	NOR-2 Coupling 2" Male Connection
572941	Instantaneous Coupling 2" Male Connection

# FOAM CONCENTRATES

## UNIVEX 3-3% M AR

- Class B Fires
- 10 Year shelf life
- For fires in Polar solvents or Hydrocarbons or a mixture of both

### Benefits

- Our Univex 3-3 M AR meets the latest IMO regulations making it ideal for updating your vessels' foam firefighting system
- Ideal for use on both your Oil and Chemical Tankers' foam systems giving you fleet standardisation
- When stored correctly in accordance with the manufacturer's guidelines or in the containers it is supplied in, it will generally have a shelf life in excess of 10 years
- Global availability, fleet flexibility and standardisation make it ideal for a long-term solution



### Ordering Information

Product Number	Product Name
1097061	Foam Concentrate UNIVEX 3-3M 20L 3-3% FP-AR
1097062	Foam Concentrate UNIVEX 3-3M 200L 3-3% FP-AR

### Approvals

EN 1568:2008 – Parts 1,3,4,  
IMO MSC.1/ Circ. 1312  
MED Modules B and D  
ICAO– Level B



### TECHNICAL DATA

Type	Fluoroprotein Alcohol Resistant
Usage	Monitors and Portable Applicators
Pump	Centrifugal
Density kg/L @ 20 °C	1.14 ± 0.02
Viscosity 20 °C mm <sup>2</sup> /s	10.0 ± 2.0
pH @ 20 °C	6.0 - 8.0
Freezing Point	-18 °C
Pour Point	≤ -15 °C
Storage Temperature	-13 °C to +60 °C
Sediments, Max (%Vol)	< 0.25
Expansion	Low
Expansion Ratio	7 times
Drainage Time 25 %	5:00 min

### FOAMS ON REQUEST

Products		Product	Approvals	Can	Drum	Foam Top-up	Replacement Foam	Can	Drum
FluoroProtein AlcoholResistant (FP-AR)	3-3%	UNIVEX 3-3 SUPER	MED/DNV/NK/RMRS	764987	764985	UNIVEX 3-3M AR	UNIVEX 3-3 M AR	1097061	1097062
		SF-FP/AR 3-3%	CCS	1089178	1057376	Not Available	UNIVEX 3-3 M AR		
FluoroProtein AlcoholResistant (FP-AR)	3-6%	UNIVEX 3-6 SUPER	MED/DNV/RMRS	764988	764986	use prod. itself, but will be superseded.	UNIVEX 3-3 M AR <sup>1</sup>		

1) required adjustment of proportioner, contact Survitec for advice

### SUPERSEDED FOAMS

Products		Product	Approvals	Can	Drum	Foam Top-up	Replacement Foam	Can	Drum
FluoroProtein AlcoholResistant (FP-AR)	3-3%	UNIVEX 3-3 UNIVERSAL	Not Available	677229	677195	UNIVEX 3-3 SUPER	UNIVEX 3-3 M AR	1097061	1097062
	3-6%	UNIVEX 3-6 UNIVERSAL	Not Available	574715	556126	UNIVEX 3-6 SUPER	UNIVEX 3-6 SUPER	764988	764986

# FOAM CONCENTRATES

## APIROL FX 3%

- Class B Fires
- 10 Year shelf life
- For fires in Hydrocarbons

### Benefits

- Our Apirol FX3 meets the latest IMO regulations making it ideal for updating your vessels' foam firefighting system
- Ideal for use on your Oil Tankers' foam systems
- When stored correctly in accordance with the manufacturer's guidelines or in the containers it is supplied in, it will generally have a shelf life in excess of 10 years
- Global availability, latest IMO regulations, fleet flexibility and standardisation make it ideal for a long-term solution



### Ordering Information

Product Number	Product Name
1097058	Foam Concentrate APIROL FX3 C 3% 20L FP
1097059	Foam Concentrate APIROL FX3 C 3% 200L FP

### TECHNICAL DATA

Type	Fluoroprotein
Usage	Monitors and Portable Applicators
Pump	Centrifugal
Density kg/L @ 20°C	1.12 ± 0.02
Viscosity 20 °C mm <sup>2</sup> /s	6.0 ± 4.0
pH @ 20 °C	6.0 - 8.0
Freezing Point	-15 °C
Pour Point	≤ -12 °C
Storage Temperature	-10 °C to + 60 °C
Sediments, Max (%Vol)	< 0.1
Expansion	Low
Expansion Ratio	7 times
Drainage Time 25 %	5:00 min

### Approvals

UL Standard 162, Foam Liquid Concentrates  
EN 1568:2008 – Parts 1, 3  
IMO MSC.1/Circ.1312  
MED Modules B and D



### FOAMS ON REQUEST

Products		Product	Approvals	Can	Drum	Foam Top-up	Replacement Foam	Can	Drum
FluoroProtein (FP)	3%	FLUOR-FOAMOUSSE 3% F-15 PD5313	MED/BV/LR/CCS	1095119	1095120	use product itself	APIROL FX3	1097058	1097059
		UNIROL 3	MED/DNV/NK/RMRS	592204	556084	APIROL FX3			
		SF-P3%	CCS	1089179	1057388	Not Available			

### SUPERSEDED FOAMS

Products		Product	Approvals	Can	Drum	Foam Top-up	Replacement Foam	Can	Drum
Protein (P)	3%	UNIMIN P3	Not Available	576454	556050	Not Available	APIROL FX3	1097058	1097059
	6%	UNIMIN P6	Not Available	574723	Not Available	Not Available	APIROL FX3 <sup>1</sup>		
FluoroProtein (FP)	6%	UNIROL 6	Not Available	592212	556076	Not Available	APIROL FX3 <sup>1</sup>		

1) required adjustment of proportioner, contact Survitec for advice

# FOAM CONCENTRATES

## AFFF 1% F-25 PD4142

- Class B fires
- 10 Year shelf life
- For fires in Hydrocarbons

### Benefits

- Our AFFF 1% F-25 meets the latest IMO regulations making it ideal for updating your vessels' foam firefighting system
- Ideal for use for your Oil Tankers' and helidecks' foam systems
- When stored correctly in accordance with the manufacturer's guidelines or in the containers it is supplied in, it will generally have a shelf life in excess of 10 years
- Global availability, fleet flexibility and standardisation make it ideal for a long-term solution



### Ordering Information

Product Number	Product Name
777696	Foam Concentrate AFFF 1 % F-25 20 L Can
777695	Foam Concentrate AFFF 1 % F-25 200 L Drum

### TECHNICAL DATA

Type	Synthetic AFFF
Usage	Monitors and Portable Applicators
Pump	Centrifugal
Density kg/L @ 20°C	1.06 ± 0.02
Viscosity +20 °C (IMO 3.4) mm <sup>2</sup> /s	< 20
Viscosity 0°C (IMO 3.4) mm <sup>2</sup> /s	< 50
Viscosity -15 °C (IMO 3.4) mm <sup>2</sup> /s	< 200
pH at 20 °C	6.5 - 8.5
Storage temperature	-25 °C to + 50 °C
Freezing Point	-20 °C
Sediments, Max (% Vol)	None
Sediments By Aging, Max at -25 °C	< 0.25
Sediments By Aging, Max at +60 °C	< 0.25
Expansion	Low
Expansion Ratio	15 times
Drainage time 25%	2-4 min
Drainage Time 50 %	4-8 min

### Approvals

Approved to IMO MSC.1/Circ.1312, MED/3.58.



### FOAMS ON REQUEST

Products		Product	Approvals	Can	Drum	Foam Top-up	Replacement Foam	Can	Drum
AFFF	1%	AFFF1% F-15 PD4141	MED/DNV/ICAO	777690	777690	STHAMEX AFFF 1% F-25 PD4142	AFFF 1% F	777696	777695

### SUPERSEDED FOAMS

Products		Product	Approvals	Can	Drum	Foam Top-up	Replacement Foam	Can	Drum
AFFF	1%	UNIRAL 1	Not Available	677211	677187	Not Available	AFFF 1% F	777696	777695



# FOAM CONCENTRATES

## AFFF 1% F

- Class B fires
- 10 Year shelf life
- For fires in Polar solvents or Hydrocarbons or a mixture of both

### Benefits

- Our AFFF 1% F meets the latest IMO regulations making it ideal for updating your vessels' foam firefighting system
- Ideal for use for your Oil Tankers' and helidecks' foam systems
- When stored correctly in accordance with the manufacturer's guidelines or in the containers it is supplied in, it will generally have a shelf life in excess of 10 years
- Global availability, fleet flexibility and standardisation make it ideal for a long-term solution



### Ordering Information

Product Number	Product Name
1094771	Foam Concentrate AFFF 1 % F 25 L Can
1094772	Foam Concentrate AFFF 1 % F 200 L Drum

### Approvals

Approved to IMO MSC.1/Circ.1312, MED/3.58.



### TECHNICAL DATA

Type	Synthetic AFFF
Usage	Monitors and Portable Applicators
Pump	Centrifugal
Density kg/L @ 20 °C	1.035 ± 0.01
Viscosity +20 °C mm <sup>2</sup> /s	< 19.3
pH at 20 °C	6.5 - 8.5
Storage temperature	-14 °C to + 55 °C
Freezing Point	-14 °C
Sediments, Max (% Vol)	<0.2
Expansion	Low
Expansion Ratio	7-8 times
Drainage Time 25%	2.5 min
Drainage Time 50%	5.5 min

### FOAMS ON REQUEST

Products		Product	Approvals	Can		Drum		Replacement Foam	Replacement	
				Can	Drum	Can	Drum		Can	Drum
AFFF	1%	STHAMEX AFFF1% F-15 PD4141	MED/DNV/ICAO	777690	777689	STHAMEX AFFF 1% F-25 PD4142		AFFF 1% F	1094771	1094772
		HYDRAL 1 M	MED/ICAO	1097070	1097071	HYDRAL 1 M				

### SUPERSEDED FOAMS

Products		Product	Approvals	Can		Drum		Replacement Foam	Replacement	
				Can	Drum	Can	Drum		Can	Drum
AFFF	1%	UNIRAL 1	no class approval	677211	677187	Not Available		AFFF 1% F	1094771	1094772

# FOAM CONCENTRATES

## AFFF 3% F-25 PD4344

- Class B fires
- 10 Year shelf life
- For fires in Hydrocarbons

### Benefits

- Our AFFF 3% F-25 meets the latest IMO regulations making it ideal for updating your vessels' foam firefighting system
- Ideal for use for your Oil Tankers' and helidecks' foam systems
- When stored correctly in accordance with the manufacturer's guidelines or in the containers it is supplied in, it will generally have a shelf life in excess of 10 years
- Global availability, fleet flexibility and standardisation make it ideal for a long-term solution



### Ordering Information

Product Number	Product Name
777692	Foam Concentrate AFFF F-25 3 % 20 L Can
777691	Foam Concentrate AFFF F-25 3 % 200 L Drum

### Approvals

Approved to IMO MSC.1/Circ.1312, MED/3.58.



### TECHNICAL DATA

Type	Synthetic AFFF
Usage	Monitors and Portable Applicators
Pump	Centrifugal
Density Kg/L @ 20 °C	1,050 ± 0.02
Viscosity 20 °C mm <sup>2</sup> /s	< 20
Viscosity -25 °C mm <sup>2</sup> /s	<200
pH at 20 °C	6.5 - 8.5
Storage Temperature	-25 to +50 °C
Pour Temperature	-25 °C
Sediments, Maximum (% Vol)	None
Expansion	Low
Expansion Ratio	5-10 times
Drainage Time 25%/50 %	2-4 / 4-8 min

### FOAMS ON REQUEST

Products		Product	Approvals	Can	Drum	Foam Top-up	Replacement Foam	Can	Drum
AFFF	3%	STHAMEX AFFF 3% F-15 PD4341	MED/ICAO	777686	777685	AFFF 3% F-25 PD4344	AFFF 3% F-25 PD4344	777692	777691

# FOAM CONCENTRATES

## AFFF 3% ULTRA LT

- Class B fires
- 10 Year shelf life
- For fires in Polar solvents or Hydrocarbons or a mixture of both

### Benefits

- Our AFFF 3% Ultra LT meets the latest IMO regulations making it ideal for updating your vessels' foam firefighting system
- Ideal for use your Oil Tankers' and Helidecks' foam systems
- When stored correctly in accordance with the manufacturer's guidelines or in the containers it is supplied in, it will generally have a shelf life in excess of 10 years
- Global availability, fleet flexibility and standardisation make it ideal for a long-term solution



### Ordering Information

Product Number	Product Name
1094768	Foam Concentrate AFFF 3 % Ultra LT 25 L Can
1094769	Foam Concentrate AFFF 3 % Ultra LT 200 L Drum

### Approvals

IMO MSC.1/Circ.1312, MED/3.58  
LR, HOCNF and ICAO Level B



### TECHNICAL DATA

Type	Synthetic AFFF
Usage	Monitors and portable applicators
Pump	Centrifugal
Density Kg/L @ 20 °C	1.060 ± 0.01
Viscosity mm <sup>2</sup> /s	< 18.9
pH at 20 °C	7.3 - 8.3
Freezing Point	-25 °C
Storage Temperature	-25 °C to + 55 °C
Sediments, Maximum (% Vol)	< 0.2
Expansion	Low
Expansion Ratio	7-7.3 times
Drainage Time 25 % / 50 %	3 / 5.5 min

### FOAMS ON REQUEST

Products		Product	Approvals	Can	Drum	Foam Top-up	Replacement Foam	Can	Drum
AFFF	3%	HYDRAL 3M	MED/ICAO	1097064	1097065	Use product itself	AFFF 3% Ultra LT	1094768	1094769
		UNIRAL 3M	MED/DNV/ICAO	778186	778185	HYDRAL 3M			

### SUPERSEDED FOAMS

Products		Product	Approvals	Can	Drum	Foam Top-up	Replacement Foam	Can	Drum
AFFF	3%	HYDRAL S3	no class approval	772392	772384	not available	AFFF 3% Ultra LT	1094768	1094769
		UNIRAL 3	no class approval	592238	556118	UNIRAL 3M			
	6%	UNIRAL 6	no class approval	592220	556100	not available	AFFF 3% Ultra LT <sup>1</sup>		
		STHAMEX AFFF6% F-35 PD4642	no class approval	777694	777693	not available	AFFF 3% Ultra LT <sup>1</sup>		

# FOAM CONCENTRATES

## AFFF 3-3% ARC 3x3

- Class B fires
- 10 Year shelf life
- For fires in polar solvents or hydrocarbons or a mixture of both

### Benefits

- Our AFFF 3-3% ARC 3x3 meets the latest IMO regulations making it ideal for updating your vessels' foam firefighting system
- Ideal for use for your Oil Tankers' and helidecks' foam systems
- When stored correctly in accordance with the manufacturer's guidelines or in the containers it is supplied in, it will generally have a shelf life in excess of 10 years
- Global availability, fleet flexibility and standardisation make it ideal for a long-term solution



### Ordering Information

Product Number	Product Name
1094774	Foam Concentrate AFFF 3-3% ARC 3x3 25 L Can
1094775	Foam Concentrate AFFF 3-3% ARC 3x3 200 L Drum

### Approvals

IMO MSC.1/Circ.1312, MED/3.58  
HOCNF



**HOCNF**

### TECHNICAL DATA

Type	Synthetic AFFF
Usage	Monitors and Foam Applicators
Pump	Positive Displacement
Density Kg/L @ 20 °C	1.075 ± 0.01
Viscosity mm <sup>2</sup> /s 20 °C	<2300
Freezing Point	-15 °C
pH at 20 °C	6.5 -8.5
Storage temperature	-15 °C to +55 °C
Sediments, Maximum (% Vol)	< 0.1
Expansion	Low
Expansion Ratio	7.0-7.3 times
Drainage Time 25 % / 50 %	10 / 15min

### FOAMS ON REQUEST

Products		Product	Approvals	Can	Drum	Foam Top-up	Replacement Foam	Can	Drum
AFFF	3-3%	UNIRAL AR 3-3M	MED/DNV/RMRS/ICAO	778009	778008	HYDRAL AR 3-3C	ARC 3x3 <sup>1</sup>	1094774	1094775
		MOUSSOL APS 3-3% F-15 PD3341	MED/BV/ICAO	777688	777927	Use product itself			
		HYDRAL AR 3-3C	MED/ICAO	1097067	1097068	use prod. itself, on demand			
	3-6%	UNIRAL AR 3-6M	MED.	784065	784066	Use prod. itself, but will be superseded			
764065				764066					

### SUPERSEDED FOAMS

Products		Product	Approvals	Can	Drum	Foam Top-up	Replacement Foam	Can	Drum
AFFF	3-3%	UNIRAL AR 3-3	no class approval	677203	677179	UNIRAL AR 3-3M	ARC 3x3	1094774	1094775
							ARC 3x3 <sup>1</sup>		
	3-6%	UNIRAL AR 3-6	no class approval	676981	596023	UNIRAL AR 3-6M	UNIRAL AR 3-6M	784065	784066

# HIGH EXPANSION FOAM CONCENTRATE 2% IAF PD9272

- Class B Fires
- 10 Year shelf life
- For fires in Hydrocarbons

## Benefits

- Our high expansion 2% IAF PD9272 meets the latest IMO regulations making it ideal for updating your vessels' foam firefighting system
- For use in machinery spaces for high expansion foam systems
- When stored correctly in accordance with the manufacturer's guidelines or in the containers it is supplied in, it will generally have a shelf life in excess of 10 years.
- Global availability, fleet flexibility and standardisation make it ideal for a long-term solution



## Ordering Information

Product Number	Product Name
711808	Foam Concentrate High Expansion 2 % 20 L Can
711390	Foam Concentrate High Expansion 2 % 200 L Drum

## Approvals

Approved to IMO MSC.1/Circ.1312, MED/3.61a.



## TECHNICAL DATA

Type	Inside Air Foam (IAF), synthetic
Usage	Engine Room
Density kg/L @ 20 °C	1.022 ± 1.038
Viscosity 20 °C (IMO 3.4) mm <sup>2</sup> /s	< 30
Viscosity at 0 °C mm <sup>2</sup> /s	< 70
pH at 20 °C	7.0 to 8,5
Sediments, Max (% Vol)	None
Storage Temperature	-10 °C to +50 °C
Pour Temperature	-10 °C
Cloud Temperature	-2 °C
Foam Expansion Ratio	High, > 700 times
Drainage Time 25 % Min	6.00 min
Drainage Time 50 % Min	15.00 min

## SUPERSEDED FOAMS

Products		Product	Approvals	Can	Drum	Foam Top-up	Replacement Foam	Can	Drum
HighExpansion (IAF)	2%	HOTFOAM	Not Available	676791	676783	IAF PD9272	IAF PD9272	711808	711390

# FIRE SYSTEMS

## NFF XFLOW WATER MIST SYSTEMS

The Novenco Firefighting (NFF) Water Mist Solutions can be applied for total flooding, local application firefighting (LAFF), accommodation areas, galley and duct. The versatility of the solutions presents you with the option to integrate all systems into one. The system has a unique XFlow® water mist nozzle, which spreads fine water mist that extinguishes the fire quickly, without any risk to the people or equipment. The mist droplets vary in size and circulate in the air, suppressing the supply of oxygen and absorbing the heat. This is effective at breaking the chain of combustion.



XFlow® nozzle for machinery space



XFlow® nozzle for accommodation areas



XFlow® nozzle for galley



XFlow® nozzle for duct

### Nozzle

#### TECHNICAL DATA

	LAFF	Total flooding	Accommodation	Duct	Galley
<b>Types</b>	Open	Open	Closed	Open	Open
<b>Material</b>	Brass	Brass	Brass	Brass	SST
<b>Water Capacity</b>	1.2 to 1.4 l/min/m <sup>2</sup> (q 6.7 to 7.7 bar(g))	1.4 to 1.8 l/min/m <sup>2</sup> (q 9 bar(g))	1.5 to 2.0 l/min/m <sup>2</sup>	12 l/min/m <sup>2</sup> (q 6 bar(g))	10.6 l/min/m <sup>2</sup> (q 7 bar(g))
<b>Installation Height</b>	Up to 16.5 m above object	Up to 6.6 m above object	NA	NA	NA

### Pump

#### TECHNICAL DATA

	LAFF	Total Flooding	Accommodation	Duct	Galley
<b>Type</b>	Centrifugal Multistage	Centrifugal Multistage	Centrifugal Multistage	Centrifugal Multistage	Three Bladder Tanks
<b>Material</b>	Cast Iron / Stainless Steel	Cast Iron / Stainless Steel	Cast Iron / Stainless Steel	Cast Iron / Stainless Steel	NA
<b>Voltage/ Frequency</b>	3X400/50 And 3X440/60 (Or on Request)	3X400/50 And 3X440/60 (Or on Request)	3X400/50 And 3X440/60 (Or on Request)	3X400/50 And 3X440/60 (Or on Request)	NA
<b>Insulation and Enclosure</b>	Class F, IP55	Class F, IP55	Class F, IP55	Class F, IP55	NA

### Approvals

NFF's firefighting systems are approved by MED, international marine authorities and classification societies. NFF is MED module D approved. Survitec is certified according to ISO 9001.

NFF XFlow® Local Application system is type approved and certified to be in compliance with MSC/circ. 1387 type

NFF XFlow® Total Flooding system is type approved and certified to SOLAS chapter II-2 and IMO MSC1165

NFF XFlow® Accommodation system is type approved and certified in accordance with SOLAS chapter II-2 and Res. A.800(19) as amended by MSC265

NFF XFlow® Galley and Duct systems are type approved to ISO 15371:2015

# NFF XFLOW WET PIPE AND DELUGE SYSTEMS

The Novenco Firefighting (NFF) XFlow® Wet Pipe system is designed to protect closed ro-ro and special category spaces against fires. The NFF XFlow® Deluge system is developed for protection of small open ended ro-ro and special category spaces. Both systems have prescriptive system design and meet the latest IMO MSC.1/Circ.1430 regulation, providing improved fire protection for ro-ro and ro-pax vessels. The NFF XFlow Wet Pipe and Deluge Systems are designed for marine applications and delivered with necessary certificates and approvals. For easy access to support and service, Survitec marine and fire solutions takes responsibility for the system throughout its lifetime, including consultancy, design, system delivery, commissioning and service.



## Deluge nozzles

### TECHNICAL DATA

Nozzle Type	Deck height ≤ 2.5 m		2.5 m < deck height ≤ 6.5 m		6.5 m < deck height ≤ 9 m		Data sheet no.
	Min. nozzle pressure [bar]	Discharge density [mm/min]	Min. nozzle pressure [bar]	Discharge density [mm/min]	Min. nozzle pressure [bar]	Discharge density [mm/min]	
NF9A-RR	1.2	6.1	X	X	X	X	56-09-451
NF11A-RR	X	X	1.9	10.8	3.8	15.3	56-09-452
NF13A-RR	X	X	1.2	12.3	2.1	15.9	56-09-453

## Automatic sprinklers

### TECHNICAL DATA

Nozzle Type	Deck height ≤ 2.5 m		2.5 m < deck height ≤ 6.5 m		6.5 m < deck height ≤ 9 m		Data sheet no.
	Min. nozzle pressure [bar]	Discharge density [mm/min]	Min. nozzle pressure [bar]	Discharge density [mm/min]	Min. nozzle pressure [bar]	Discharge density [mm/min]	
NF9A-RR-T68	1.2	6.1	X	X	X	X	56-09-451
NF11A-RR-T68	X	X	1.9	10.8	3.8	15.3	56-09-452
NF13A-RR-T141	X	X	1.2	12.3	2.1	15.9	56-09-453
NF13A-RR-T141	X	X	1.9	15.5	3.2	20.1	56-09-553

## Approvals

According to the new IMO MSC.1/Circ.1430 regulation, all ro-ro and ro-pax vessels shall have a fixed firefighting system for ro-ro spaces and special category spaces. The systems shall suppress fires on open ended decks and in enclosed spaces where vehicles and passengers have access.

The new regulations were introduced after several accidents with ro-ro fires. Investigations into existing requirements for water-based systems, done by SP, proved that existing coverage according to IMO resolution A.123, a drencher system with 5 lpm/m<sup>2</sup> was not sufficient. Therefore, the new MSC.1/Circ.1430 regulation reflecting the requirements for prescriptive and performance-based systems from the SP tests was adopted.

# NFF XFLOW® MOBILE WATER MONITOR AND WATER MIST LANCE



Regulation states that vessels carrying containers on or above the weather deck, constructed on or after January 2016 shall carry at least one water mist lance. Further, vessels designed to carry five or more tiers of containers on or above the weather deck, shall carry a number of mobile water monitors.

The Novenco Firefighting (NFF) XFlow® Mobile Water Monitor and Water Mist Lance are designed to protect ships carrying containers on or above weather deck. For easy access to support and service, Survitec takes responsibility for the solution throughout its lifetime, including consultancy, product delivery and service inspections.

## Water Mist lance

### KIT CONTENT

Aluminium portable case	1pc
Spray gun with storz D coupling and lance section	1pc
Lance section with water mist nozzle	1pc
Drilling machine 18V (IP23)	1pc
Drill extension	2pc
Hex key for drill extensions	1pc
Cup drill	1pc
Extra battery and charger	1pc
Fire hose with Storz C-D adaptor coupling	1pc
Assembly / operations guide	1pc

### PORTABLE CASE

Case size (W x H x D)	760 x 520 x 220 mm
Length of assembled lance	1180 mm
Length of drill with extension(s)	680 - 1100 mm

### LANCE

Inlet lance	Storz D
Inlet hose	Storz D or C (Adapter)
Nominal flow and pressure	25 lpm @ 4 bar
Max. working pressure	16 bar
Nozzle K-factor	11.1
Drill power	18V
Drill size	Ø 30mm
Battery charger connection	230V Europlug (CEE 7/16)
Weight of kit	15 kg

## Ordering Information

Product Number	Product name
M23101-0	NFF XFlow® Mobile Water Monitor
1093614	NFF XFlow® Water Mist Lance

## Mobile Water Monitor

### MONITOR

Inlet	2 x Storz C adapters (52mm)
Nozzle Connection	External thread G 2½"
Nozzle Type	Dual purpose spray/jet
Max. working Pressure	16 bar
Working Pressure	Minimum 1.5 bar Nominal 4 bar
Capacity	Minimum 36.7 m³/h Nominal 60 m³/h
Throw Length	Nominal 40 m
Throw Height	Minimum 12 m Nominal 29 m
Pivoting area	
Horizontal Rotation	360°
Elevation Range	-60° to +120°
Dimensions (for nozzle elevation 45°)	
Length	Approx. 1200 mm
Height	Approx. 560 mm
Width (legs folded)	Approx. 670 mm
Width (legs extended)	Approx. 1200 mm
Weight of Monitor with Nozzle	~20 kg

## Approvals

MED

Specific standard: SOLAS 74 Reg.II-2/10 IMO.1Circ.1472

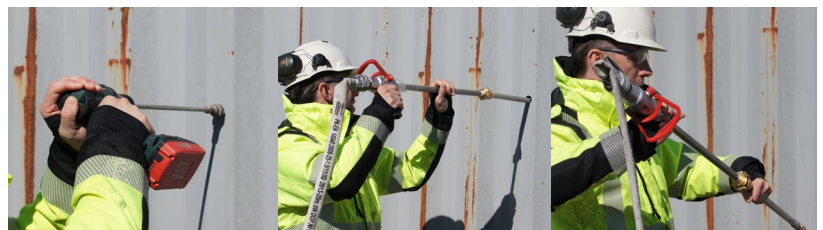



# DRY CHEMICAL POWDER SYSTEM

Gas carriers have specific cargo containment and handling requirements due to the highly volatile nature of their cargo. In the event that flammable gases are ignited, extinguishing solutions that can be deployed quickly and effectively whilst minimising the risk to personnel and environment is required.

Dry Chemical Powder fire extinguishing system (DCP system) breaks down the chemical reaction within the fire and suppresses the flames almost immediately. The system is an effective, non-toxic alternative and is harmless to people and the environment. The system is extensively and independently tested, ensuring regulatory compliance. It can be applied on merchant marine and offshore structures as the design is in accordance with IGC and IBC codes.



## TECHNICAL DATA

<b>Tanks</b>	
<b>Material</b>	Steel
<b>Capacity</b>	160 - 2500 kg
<b>Pressure Class</b>	PN16
<b>Certification</b>	As required by Class
<b>Cylinders</b>	
<b>Material</b>	Steel
<b>Capacity</b>	50 L
<b>Pressure</b>	200 bar
<b>Certification</b>	As required by Class
<b>Powder</b>	
<b>Type</b>	BC Karate (Potassium Sulphate)
<b>Monitor</b>	
<b>Material</b>	Stainless Steel
<b>Capacity</b>	10 - 25 kg
<b>Flange Connection</b>	DN50 and DN65
<b>Pistol</b>	
<b>Material</b>	Stainless Steel
<b>Capacity</b>	3.5 kg
<b>Cabinets</b>	
<b>Material</b>	Stainless steel
<b>Type of Operation</b>	Pneumatic

### Approvals

The DCP system is extensively and independently tested to MED -B & -D certified, fulfilling the mandatory IMO MSC.1/Circ. 1315, DNV-GL type approval certificate, DNV QS - Certificate of assessment - EC

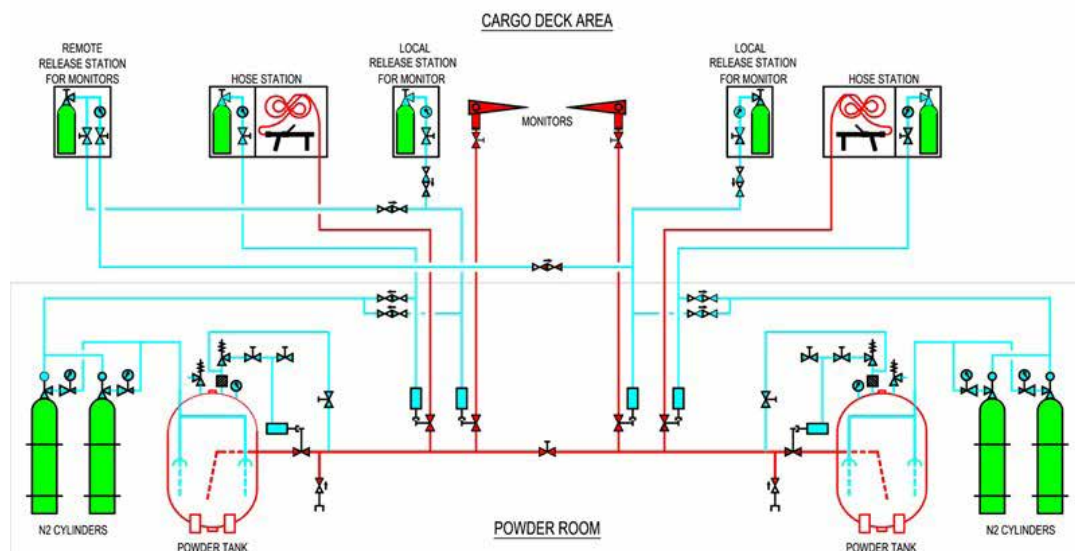

# 1230 CLEAN AGENT SYSTEM

Traditionally, fire extinguishing systems for the offshore and maritime industry have contained components harmful to the environment and personnel, such as Halon and CO<sub>2</sub>. The 1230 system is a high quality, compliant fire extinguishing system using a clean agent. The system is both environmentally friendly and harmless to people. The solution is particularly suited for rooms with sensitive equipment and vessels where space is limited.

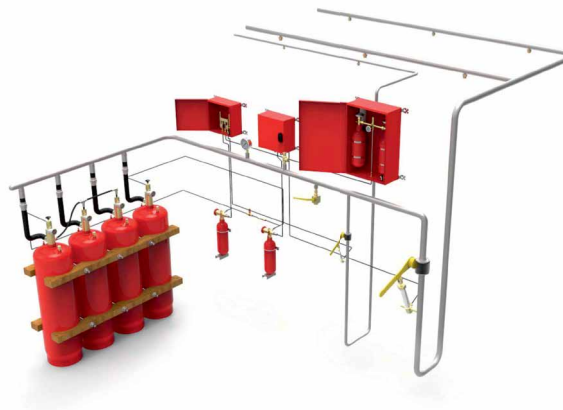

## Approvals

The Survitec 1230 system fulfils the requirements of IMO MSC/Circ. 848 and MSC.1/Circ. 1267, and is equivalent to Fire Extinguishing Systems required by SOLAS 1974 as amended, Chapter II-2. The system can be applied on merchant maritime and offshore structures as design is in accordance to SOLAS, class requirements and IMO MODU Code.



## Environmental properties comparison

The below table compares Novec 1230 fluid with other gaseous fire extinguishing agents in the market:

Properties	Novec 1230	Halon 1211	Halon 1301	HFC-227ea (FM-200)	HFC-236fa	HCFC Blend B
Ozone Depleting Potential (ODP)	0.0	4.0	12.0	0.0	0.0	0.014
Global Warming Potential-IPCC 2001 <sup>1</sup>	1	1300 <sup>2</sup>	6900 <sup>2</sup>	3500	9400	120 <sup>3</sup>
Atmospheric Lifetime (years)	0.014	11.0	65	33	220.0	1.4
SNAP (Yes/No)	Yes	No	No	Yes	Yes	Yes/Phase-out

1 IPCC Intergovernmental Panel on Climate Change Method 100 Year (ITH)

2 Global Warming Potential 1998 WMO Method 100 Year (ITH)

3 Data based on HCFC-123 only -- also contains CF4

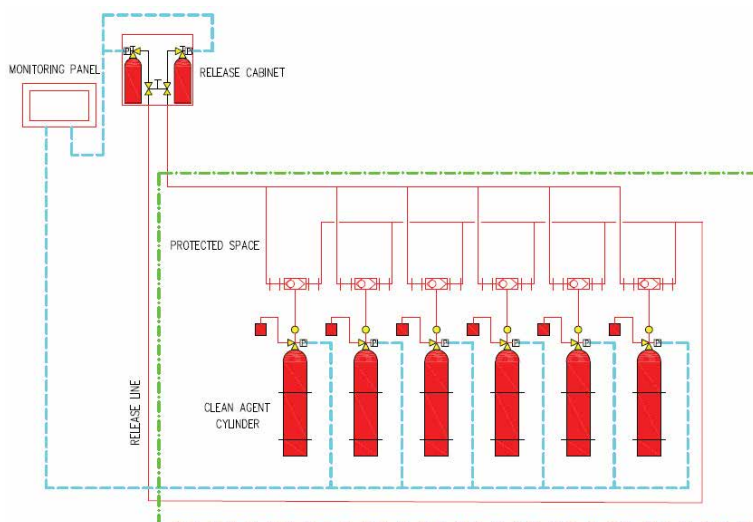

# INERGEN® CLEAN AGENT SYSTEM

- Inergen is the only fire extinguishing system that is frequently demonstrated with an audience inside the protected room
- It contains 8% CO<sub>2</sub>. This means that the body can absorb as much oxygen as it would in a normal atmosphere
- It is stored in cylinders as compressed gas and does not create fog in the protected room when released

## Benefits

- Inergen does not decompose or react with other components in the fire. This eliminates corrosion or residual harmful agents in the protected space
- Inergen has no Ozone Depletion Potential (ODP) and no Global Warming Potential (GWP)



## TECHNICAL DATA

Gas	
<b>INERGEN®</b>	Extinguishing gas for fixed installations
<b>Gas Composition</b>	52% nitrogen (N <sub>2</sub> ) 40% argon (Ar) 8% carbon dioxide (CO <sub>2</sub> )
<b>NFPA Designation</b>	IG541
<b>Discharge Time After Release</b>	120 s-
Cylinders	
<b>Volume</b>	5 to 80 L
<b>Pressure</b>	200/300 bar
<b>Gas Volume</b>	1 to 24 Nm <sup>3</sup>
<b>Weight Empty</b>	9 to 108 kg
<b>Weight Filled</b>	11 to 140 kg
<b>Test Pressure</b>	300/450 bar
<b>Colour</b>	Red, with green shoulder
<b>Height</b>	465 to 1780 mm
<b>Diameter</b>	140 to 267 mm
<b>Standard &amp; Approval</b>	EN1964-2, π TPED EC1999/36

## Approvals

The Inergen system can be applied on merchant marine and offshore structures as its design is in accordance to SOLAS and IMO MODU Code. It is tested according to the IMO test standards and has approvals from Classification Societies, UL, FM as well as other national authorities around the world.

It is approved according to NFPA 2001 as a Halon gas alternative and is listed as a clean agent.

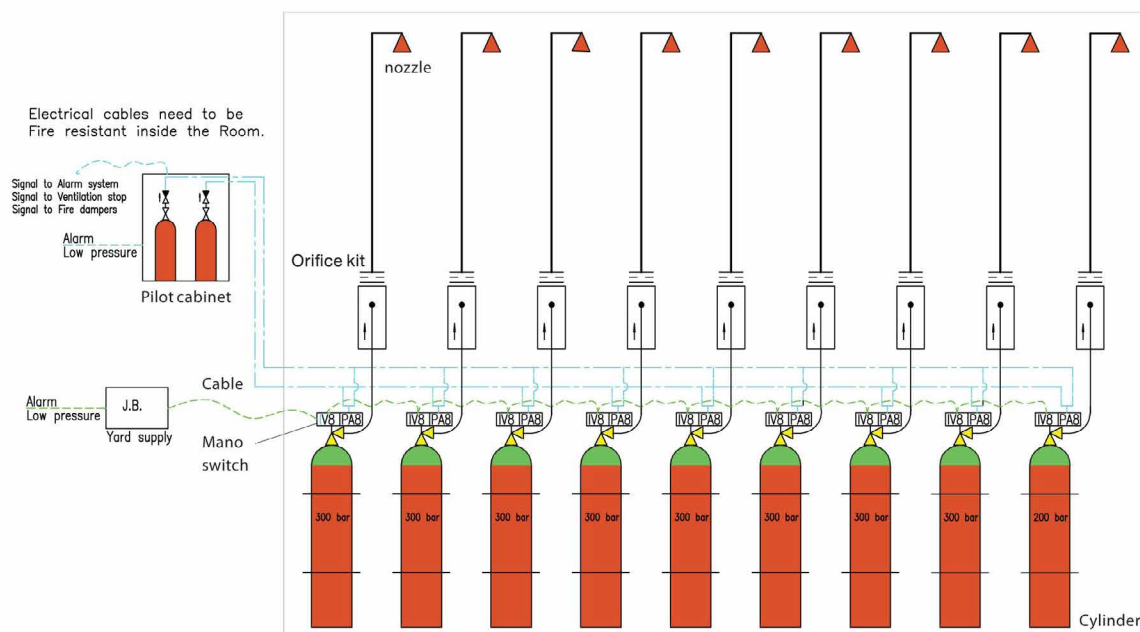

# HIGH PRESSURE CO<sub>2</sub> SYSTEM

- Options of manual or pressure operated cylinder top valves to quickly discharge the CO<sub>2</sub> gas
- operated with self contained power source in release cabinets CO<sub>2</sub> pilot Cylinders, no need for an external power source
- The system is equipped with alarm devices which will pre-warn the crew to evacuate the protected space
- A safe release delay function to ensure the safety of the crew
- sequential release design ensures safe and effective operation according to class rule

## Benefits

- A cost effective solution for optimal system performance, keeping both installation and operational costs low
- The system is available on rack modules to save on installation time and costs
- Quick discharge reduces potential cost of damages
- Minimal and easy maintenance keeps operational costs low

## Approvals

The Survitec CO<sub>2</sub> system is designed in accordance to SOLAS, Chapter II-2, Part C, Reg. 10 FSS Code, Chapter 5 IBC Code IGC Code Classification societies rules and regulations Authorities rules and regulations other standards (EN, ISO, DOT, etc). The system is type approved by all major classification societies.



## TECHNICAL DATA

Cylinders	
Volume	67.5/80 L
Weight of CO <sub>2</sub> Gas	45/55 kg
Weight of Filled Cylinder	125/140 kg
Storage Pressure at 20 °C	60 bar
Test Pressure	250 bar
Certificates	All Major Classes
Standard	ISO, DOT, EN
Distribution Valves	
Sizes	DN20 to DN150
Nominal Pressure	PN100 and PN160
Material of Construction Body	Steel
Stem and Ball	Stainless Steel
Certificates	DNV or according to specifications
Release Cabinet	
Cylinders	2.68 L with 1.78 kg CO <sub>2</sub>
Degree of Protection	IP55

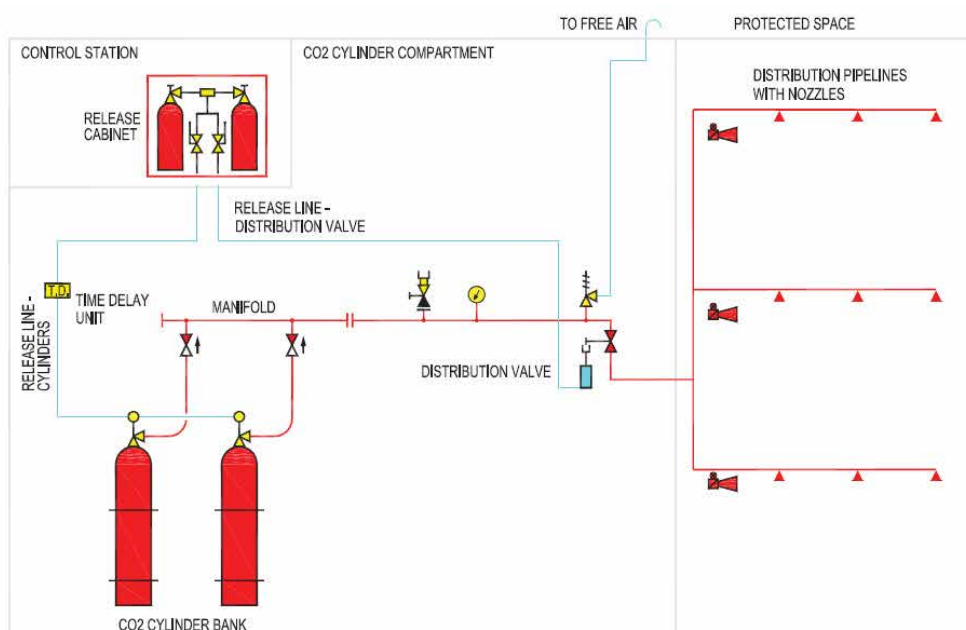

# DECK FOAM SYSTEM

- The low expansion foam quickly blankets the fire and prevents further outbreak
- A balanced pressure proportioner guarantees reliable foam mixing from 1-3 % ratio
- Foam Monitors and portable applicators can be used individually or in conjunction
- Fixed Foam monitors are used to fight fire from a predetermined safe distance, while portable applicators and nozzles cover shadow areas not reachable by the monitors
- Sturdy and compact Foam monitors are adjustable and can be used in two modes: jet or fog
- It comes in two operating options: manual or remotely controlled with hydraulics

## Benefits

- A cost effective solution, keeping both installation and operational costs low
- Designed for optimal system performance
- Components delivered on modular units reduces installation cost
- Minimal and easy maintenance keeps operational cost low
- Easy operation
- Modular skid based units provides easy installation and reduced footprint
- Corrosion resistance component materials and coatings provide a robust, low maintenance system
- For services purposes, foam concentrate replacements are delivered worldwide
- Flexible, high quality and compliant system

## Approvals

The Survitec Deck Foam system has been extensively and independently tested to; SOLAS Ch.II-2 Reg.10, FSS Code Ch14, IBC Code Reg.11, All foam concentrates including alcohol resistant foams, comply with IMO MSC/Circ.1312, Authorities rules and regulation, Classification societies rules and regulations, Other standards (EN, ISO, DOT, etc.)

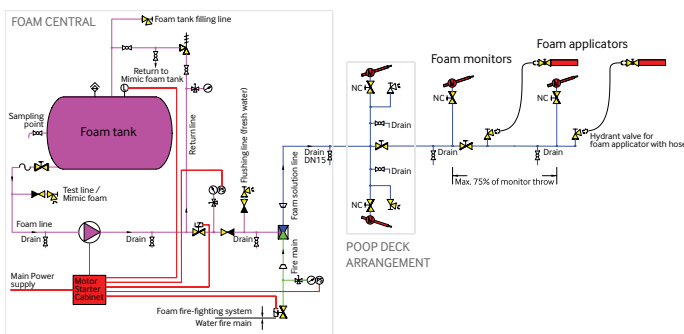

## TECHNICAL DATA

Foam Monitor	
Capacity	1,000 - 12,500 L/min
Material	Stainless Steel
Max Working Pressure	16 bar
Operation	Manual or Remote Hydraulic
Foam Applicator	
Capacity	200 and 400 L/min
Material	Stainless Steel
Pressure	3 or 6 bar
Self-inducting applicators available 3 - 6 %	
Pump	
Type	Centrifugal Multi-stage & Positive Displacement
Material	Stainless Steel
Voltage / Frequency	3 x 400/50, 3 x 440/60 V/Hz
Mixing Equipment	
Type	Balanced Pressure Proportioner
Capacity	75 to 20,000 L/min
Material	Stainless Steel and Bronze
Mixing Ratio	1 - 3 %
Foam Concentrate	
Types	Fluoro-Protein foam FP 3 % Aqueous film-forming foam (synthetic) AFFF 1% or 3 % Fluoro-protein alcohol resistant foam FPAR 3 - 3 % Aqueous film-forming alcohol resistant foam (synthetic) AFFFAR 1 - 1 % or 3 - 3 %
Tank	
Type	Cylindrical or Cubal
Material	Glass Fibre Reinforced Polyester (GRP) Stainless Steel on Request
Opening	Full size man hole for inspection

# HIGH EXPANSION FOAM SYSTEM

- Fast and effective solution with filling up to 1.8 m/min
- The system can be installed as a total flooding solution for the entire machinery space or for individual compartments
- Quick activation of the system minimises fire and heat damage to equipment and structures
- The foam is not harmful to the crew
- It has a cooling effect which helps prevent re-ignition of the fire
- No hazardous decomposition products is formed that could cause damage
- Expansion ratio up to 1:666 at nominal pressure of 6 bar using inside air



## TECHNICAL DATA

### Generators

#### Foam Capacity

UFG-90	60 m3/min
UFG-60	40 m3/min
UFG-30	20 m3/min
<b>Material</b>	Stainless Steel
<b>Nominal Working Pressure</b>	6 bar
<b>Expansion Ratio</b>	1:666
<b>Connection Flange</b>	DN 20
<b>Filling Rate</b>	1.63 m/min

### Foam Concentrate

<b>Type</b>	Synthetic
<b>Viscosity [cSt] @ -2°C</b>	<70
<b>Lowest Working Temperature</b>	-10 °C
<b>Storage Temperature</b>	-10 °C to +45 °C
<b>Approval</b>	MED, CCS and NK certified

### Mixing Equipment

<b>Type</b>	Balanced Pressure Proportioner
<b>Capacity</b>	75 to 20,000 L/min
<b>Material</b>	Stainless Steel and Bronze

## Approvals

The Survitec high foam system can be applied on merchant marine and offshore structures as it is designed in accordance to SOLAS and IMO MODU Code. The system is approved by all major classification societies. SOLAS, Chapter II-2, Part C, Reg. 10, FSS Code, Chapter 6, IMO MSC/Circ. 1384 and 670, Classification societies rules and regulations, MED 2014/90/EU approved

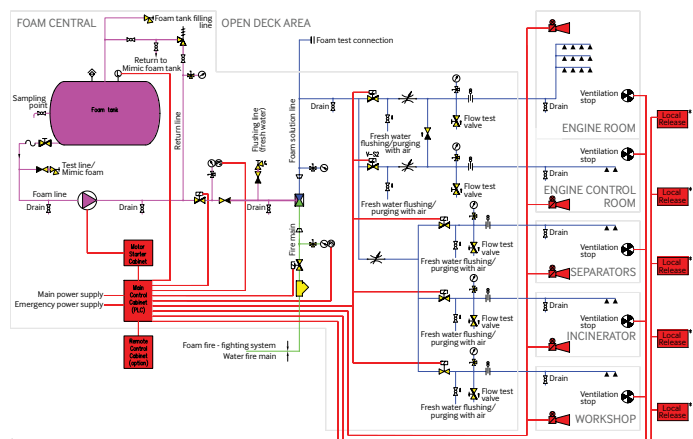

\* Local Release Cabinets located outside protected spaces

# DEEP FAT COOKING FIRE SYSTEM

- Use a standard 9 litres water fire extinguisher with additives
- Provide protection for up to three deep fat fryers
- Easy and low cost installation with standard components
- All components on the galley hood in stainless steel
- All tubing and fittings of low pressure type
- Automatic operation with detection
- No electrical power required for operation

Deep-Fat Cooker FireExtinguishing System

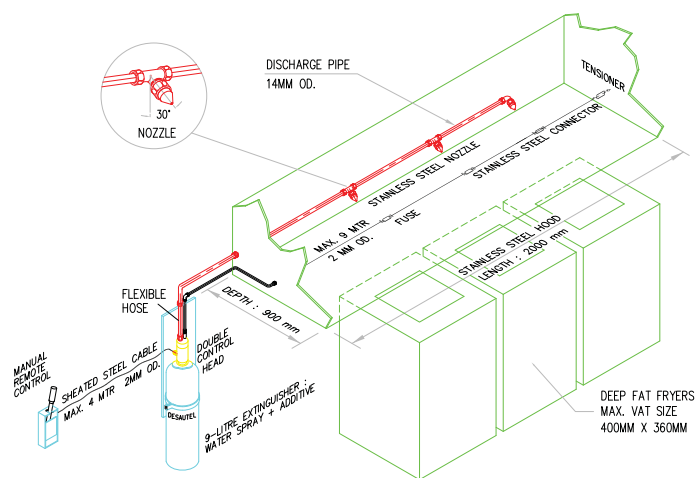

## Approvals

Tested according to ISO 15371: 2009, Comply with SOLAS and approved by major classification societies (IACS), MED (Marine Equipment Directive) approved



## Accessories

Product Number	Product Name
1054976	Recharge Kit For DFC9
1054977	2 Nozzles and Fusible Links Kit
1054978	1 Nozzle and Fusible Link Kit
1095591	Nozzle for DFC9 System



## TECHNICAL DATA

Extinguisher	
Material	Steel, with Primer & Polyester Coating
Colour	Red, RAL 3000
CO <sub>2</sub> cartridge size	80 g
Capacity	9 L
Test pressure	26 bar
Pressure at Activation	6.5 bar
Design standard	NF – EN3, MED
Weight	
Empty without Trigger	6 kg
Full with Trigger	16 kg
Trigger	
Material	Steel, Chrome Plated
Dimension Ø x w	38 x 174 mm
Weight	<1000 g
Fixing details	Bolt and Nut, M8
Switch	1 pari NO/NC, IP 65
Nozzle	
Material	stainless steel, 316 L
Type	BF4
Flow rate at 3 bar	0,98 (l/min)
Fixing details	bolt and nut. M8
Pipe	
Material	stainless steel, 316 L

# FIRE PROTECTION & DETECTION

Gas carriers, chemical carriers and some oil tankers need a system to prevent cargo from catching fire, explosions in the cargo or void space and to prevent damage by air and moisture. This can be achieved by keeping the oxygen content below 8 %, a standard set by the International Maritime Organisation (IMO).



“  
Our technicians  
complete over 21,000  
multi-brand services  
annually”



# PERSONAL FIRE PROTECTION

## FIREBUDDY PLUS FIRE FIGHTERS OUTFIT

- The jacket has a stand-up collar, elasticated cuffs and is closed by a zip covered by an overlapping front
- The touch and close fastening and elasticated trouser braces allow for the suit to be donned quickly
- Generous suit sizing to allow for additional clothing
- Gloves, boots and helmet are en approved in accordance with MED ships wheel
- Soft flexible materials to provide movement

### Benefits

- The 4-layer construction ensures thermal protection whilst providing you with high comfort factors using breathable materials
- Our softer materials even with 4 layers give you flexible movement which is a crucial element when you need to enter confined spaces or be physically active
- The touch and close fastening and elasticated trouser braces allow you to put on the suit quickly
- Our suit sizing is generous allowing you the choice to wear additional clothing



### TECHNICAL DATA

	Medium	Large	Extra Large
<b>Height</b>	164-182 cm	170-188 cm	176-194 cm
<b>Chest</b>	84-104 cm	96-116 cm	112-132 cm
<b>Waist</b>	84-104 cm	96-116 cm	112-132 cm
<b>Inside Leg</b>	74 cm	79 cm	84 cm

### Ordering Information

Product Number	Product Name
<b>775620</b>	<b>Firebuddy Plus Outfit Size Medium*</b>
<b>775621</b>	<b>Firebuddy Plus Outfit Size Large*</b>
<b>775622</b>	<b>Firebuddy Plus Outfit Size Extra Large*</b>

### Accessories

Product Number	Product Name
766803	MED Fire Fighter Boots Size 41
766804	MED Fire Fighter Boots Size 42
<b>766805</b>	<b>MED Fire Fighter Boots Size 43*</b>
<b>766806</b>	<b>MED Fire Fighter Boots Size 44*</b>
766807	MED Fire Fighter Boots Size 45
766808	MED Fire Fighter Boots Size 46-47
775361	Gloves For Firefighting Suit
<b>777539</b>	<b>Lamp Holder for PAB Fire Fighters Helmet*</b>
<b>777538</b>	<b>Led Lamp for PAB Fire Fighters Helmet*</b>
<b>534958</b>	<b>Fire Axe with Insulated Handle 2 kV*</b>
775379	Fire Fighters Suit Insulated Gloves

APPROVALS  
MED/SOLAS



# FIRE FIGHTERS SUIT FLAMEGUARD MK3 SOLAS KIT

- Latest approvals
- New technology materials
- Complete kit for Non MED vessels
- One size fits most
- When you order you receive the full kit of suit, boots, helmet, external flameguard gloves and internal insulated gloves

## Benefits

- The Flameguard SOLAS has recently been approved, giving you compliance for years to come
- New materials which improve the bonding of aluminium and the cotton backing give you a longer life and improved levels of usage performance
- The large is generously sized and with the braces and adaptable closures will cover a large proportion of your crew particularly if you have a regular change of crew



## TECHNICAL DATA

	Medium	Large	Extra Large
<b>Height</b>	164-182 cm	170-188 cm	176-194 cm
<b>Chest</b>	84-104 cm	96-116 cm	112-132 cm
<b>Waist</b>	84-104 cm	96-116 cm	112-132 cm
<b>Inside Leg</b>	74 cm	79 cm	84 cm

## Ordering Information

Product Number	Product Name
775148	Flameguard MK3 SOLAS Kit Medium
<b>775155</b>	<b>Flameguard MK3 SOLAS Kit Large*</b>
775163	Flameguard MK3 SOLAS Kit Extra Large

## Accessories

Product Number	Product Name
777465	Solas Fireman Boots Size 42
777466	Solas Fireman Boots Size 43
777467	Solas Fireman Boots Size 44
777469	Solas Fireman Boots Size 46
<b>534958</b>	<b>Fire Axe with Insulated Handle 2 kV*</b>
<b>658310</b>	<b>Safety Torch ATEX*</b>
790100	Atex Safety Torch with Led

## Approvals

EN1612, EN397 & EN20345

# FIRE FIGHTER BOOTS (MED)

- Fire Proof Nitrile rubber
- Polymer toe cap
- Composite anti-perforation mid-sole
- Chemical resistance
- Wide size range - 41 to 46
- Suitable for use with the Firebuddy suit

## Benefits

- These boots are suitable for emergency situations, firefighting or incidents involving the release of hazardous chemicals
- They give protection against numerous other hazards including fuels, greases, solvents, weak and diluted acids
- Tough long-lasting boots which boast excellent resistance to cuts and abrasions



## Ordering Information

Product Number	Product Name
766803	MED Fire Fighter Boots Size 41
766804	MED Fire Fighter Boots Size 42
<b>766805</b>	<b>MED Fire Fighter Boots Size 43*</b>
<b>766806</b>	<b>MED Fire Fighter Boots Size 44*</b>
766807	MED Fire Fighter Boots Size 45
766808	MED Fire Fighter Boots Size 46/47

Approvals  
MED/SOLAS



# FIRE FIGHTER BOOTS (SOLAS)

- Only for use on SOLAS approved fire fighters suits
- Generously sized
- Protective toe cap to EN20345
- Sanitised linings, sizes 42 to 46

## Benefits

- Approved to EN20345 ensures the quality of these boots to be used on your non MED fire fighter outfits
- Flexible uppers give you good levels of comfort and freedom of movement
- The sole pattern gives you good grip when climbing ladders or working on wet surfaces
- The sanitised linings help reduce foot odours



## Ordering Information

Product Number	Product Name
777465	Solas Fire Fighter Boots Size 42
777466	Solas Fire Fighter Boots Size 43
777467	Solas Fire Fighter Boots Size 44
777469	Solas Fire Fighter Boots Size 46

Approvals  
SOLAS

# FIRE FIGHTERS SUIT INSULATED GLOVES

- Insulating gloves for personal protection against electrical shocks
- Good heat insulation

## Benefits

- Used in conjunction with your fire fighter's outfit they will protect against electric shocks
- You will fully comply with the IEC regulations as these gloves are Class 00 - one of the highest levels
- As an added benefit when firefighting they also offer extremely good heat insulation
- Soft latex and ergonomically shaped - they can be put on quickly and are comfortable to wear



**Approvals**  
EN60903 & IEC 60903

## Ordering Information

Product Number	Product Name
775379	Fire Fighters Suit Insulated Gloves

# FIRE 04 HT HELMET

- Includes visor and neck curtain
- Lightweight
- Visor approved for use in fires
- Interior ventilating channels enable safe and comfortable work
- Luminescent and reflective tapes visible from all sides and in all conditions
- Nomex chinstrap - tested to prevent skin irritations
- Visor folds inside helmet when not used for added protection and is not in your line of vision
- The helmet and visor both give you high impact resistance for clearing debris or during firefighting operations
- Separate lightweight LED lamp with simple click fit



## Ordering Information

Product Number	Product Name
774943	PAB Helmet HT04 Red with Visor*

## Accessories

Product Number	Product Name
777538	Lamp for PAB Fire Fighter's Helmet*
777539	Lamp Holder for PAB Fire Fighters Helmet*

## TECHNICAL DATA

<b>Sizing</b>	52 to 63 cm
<b>Temperature Resistance</b>	Up to 1000 °C Blast
<b>Long-term resistance</b>	Up to 250°C / 30 min, radiant heat test 14 KW / m <sup>2</sup>
<b>Mechanical Impact Resistance</b>	EN 443/2008
<b>Visor Coating</b>	PES anti-scratch and anti-fog coated visor resistible up to 300 °C (EN 14458)
<b>Neck Protection</b>	Aluminized carbon-fibre
<b>Weight</b>	1.350 kg

**APPROVALS**  
MED/SOLAS



# DOUBLE SKIN LONG CAPE FLASH/TURNOUT FIRE HOOD

- 230Gsm aramid/viscose fr/anti-static fibre
- Full shoulder cape
- Low heat conductivity
- All seams sewn with 100% aramid thread
- Anti-static outer fibre
- One size fits all
- Available in one colour only (yellow)



## Approvals

MED type approved according to SOLAS 74/2009 convention.



## Ordering Information

Product Number	Product Name
FFSUIFHL	Double Skin Long Cape Turnout Fire Hood*

# FIRE FIGHTERS LINE WITH HOOK 30 M

- Galvanized steel cable IRWC 6 x 19, PP fibre core 5mm with Trevira CS braiding
- 6.6 kN breaking strength
- Snap hook and karabiner fittings

## Benefits

- Flame resistant making it ideal for use with your fire fighter's equipment
- Quick snap on or off allows quick removal if you require
- Outer protection ensures any chaffing does not affect the inner core
- Galvanised cable provides a long life in the marine environment



## Approvals

MED type approved according to SOLAS 74/2009 convention.



## Ordering Information

Product Number	Product Name
176826	Fire Fighters Lifeline with Hook 30 m*

# FIRE AXE 32 INCH

- 32" (800mm) handle
- Ash or Hickory handle
- The axe is hardened in both ends between 54-56 Rockwell hardness and epoxy coated to avoid corrosion

## Benefits

- Ash or Hickory handle for sure grip even when your hands are wet
- The axe head is toughened giving you a tool to tackle the hardest of jobs



## Ordering Information

Product Number	Product Name
755314	Fire Axe with 32 Inch Shaft

## Accessories

Product Number	Product Name
525519	Cover for Fire Axe

# BELT, HOLSTER & AXE

- Corrosion resistant fittings
- Heavy duty d ring riveted for strength
- Fits waist sizes 32 inches to 52 inches

## Axe Features

- Insulated Fire Axe – see information on page 103



## Ordering Information

Product Number	Product Name
FFAXEBELTLB	Fire Fighters Belt, Holster and Axe

## Approvals

MED type approved according to SOLAS 74/2009 convention.



# FIRE MANS WAIST BELT FHA

- 85mm Polyester belt strap
- Carabiner with security lock and multifunctional eyelet
- 2 thorn buckle
- Safety line with leather sheath



## Ordering Information

Product Number	Product Name
FFAXEBELTLB	Fire Fighters Belt, Holster and Axe

## Approvals

EN 358:2000 EN 14927:2018, CE-0158

# SAFETY TORCH ATEX

- UL Division 1 & 2 listed
- Non-conductive
- 30,000 candELA
- Pre-focused spot beam
- Supplied with a keyring lanyard and belt clip keeping hands free
- Xenon bulb gives a direct beam of 30,000 candela making it ideal for using as a marshalling baton
- Waterproof up to 100ft and able to withstand up to a 30ft drop if entry into the water is required
- Our lifetime warranty extends the reasons you should consider the Responder

## Approvals

Approved in compliance with MED



## Ordering Information

Product Number	Product Name
658310	Safety Torch ATEX*

## Accessories

Product Number	Product Name
L15991	Xenon Bulb XPR2C for Responder

## TECHNICAL DATA

Power Source	2 x C Cell batteries
Bulb Life	15 Hours
Replacement Bulb	XPR2C
Approx Max use	5 Hours

# WOLFLITE H-251ALED RECHARGEABLE HANDLAMP

- CE marked to ATEX directive explosive gas, vapour and mist
- Certified for zones 1 & 2, up to T4 temperature class
- LED light source gives increased light output and battery duration
- Discharge protection
- IP66 ingress protection
- Electronic current limited battery with power fail operation
- Robust anti-static thermoplastic lamp enclosure
- Suitable for cyclic and short-term standby applications

## APPROVALS



## TECHNICAL DATA

Light Type	Halogen filled filament bulb
Light Volts	3.75 V
Light Watts	1 W
Light Output	60 lm (peak)
Bulb Life	25,000 hrs
Power Type	Rechargeable battery, sealed lead acid
Power Volts	4 V
Power Capacity	5 Ah
Power Life	Up to 500 recharge cycles

## Ordering Information

Product Number	Product Name
638726	Wolflite Safety Lamp

## Accessories

Product Number	Product Name
638965	Wolflite Safety Lamp Battery
638973	Wolflite Safety Lamp Bulb
588301	Wolflite Safety Lamp Charger C-251HV

# FIRE EQUIPMENT CABINETS

- IP56 rated
- Lloyd's Type Test approval, making the ideal for use in demanding conditions
- The equipment cabinet provides a safe place to store all of your firefighting equipment, including fire hoses, breathing apparatus, fire extinguishers and firefighters' clothing
- The cabinets are available in a variety of standard sizes with roller-shutter or hinged doors

## Approvals

Lloyd's Type Test Approval (not including SOS101)



## Ordering Information

Product Number	Product Name
FFCABJB08FE	JB08FE Firemans Equipment Cabinet
FFCABJB10FE	JB10FE Firemans Equipment Cabinet
FFCABJB17FE	JB17FE Firemans Equipment Cabinet
FFCABJB18FE	JB18FE Firemans Equipment Cabinet
FFCABJB28	JB28 Fire Axe Cabinet

# FIRE AXE CABINET

- IP56 rated
- Lloyd's Type Test and ABS approval, making the ideal for use in demanding conditions
- The equipment cabinet provides a safe place to store all of your firefighting axes
- The axe is securely held by a 316 Stainless steel bracket

## TECHNICAL DATA

Height x Width x Depth	1076 x 463 x 320 mm
Aperture H x W	895 x 259 mm
Internal Depth	266 mm
Weight	11 kg
Colour	Red RAL 3000
Material	Lloyds approved composites with UV stabilised gelcoat
Hinge	Graphite Nylon
Handle	Nylon Rod
Seal	EPDM



## Ordering Information

Product Number	Product Name
JB28	Fire Axe Cabinet

## Approvals

Lloyd's Type Test Approval and ABS





# INERT GAS GENERATOR SYSTEMS

## INERT GAS GENERATOR

- Flexible solutions from loose equipment to turn-key deck house modules
- Easy installation - data communication between operator panels
- High grade Corrosion resistant steel used for the combustible chamber and cooling jacket
- Easy access to burner & combustion chamber for inspection and service
- Fully automatic operation with PLC control
- Modern operator screen with state of the art operator feedback
- Automatic turn down ensures best possible fuel economy



### TECHNICAL DATA

Type	Capacity [Nm <sup>3</sup> /h]	Seawater Consumption [m <sup>3</sup> /h]	Fuel Consumption [kg/h]	Power Consumption [kW]	Dimension L x W x H [mm]	Overall System Weight [kg]
MPG - 400	500	30	37.5	7.5	1830 x 800 x 2225	1150
MPG - 700	500- 2200	30 -132	37.5 - 165	7.5 - 33	3000 x 1000 x 2800	1500
MPG - 800	2200- 3200	132 - 192	165 - 240	33 - 48	3300 x 1100 x 2800	1900
MPG - 900	3200- 4500	192 - 270	240 - 337	48 - 67.5	3600 x 1200 x 4000	2200
MPG - 1000	4500- 5700	270 - 342	337 - 427	67.5 - 85	4000 x 1400 x 4500	2500
MPG - 1100	5700- 6800	342 - 408	427 - 510	85 - 102	4500 x 1400 x 4500	3000
MPG - 1300	6800- 10500	408 - 630	510 - 787	102 - 157	5400 x 1800 x 4800	5000
MPG - 1600	10500- 16000	630 - 960	787 - 1200	157 - 240	6000 x 2100 x 5025	7000
MPG - 1600L	16000- 17500	960 - 1050	1200 - 1312	240 - 262	7000 x 2100 x 5025	9000

Table based on 3 % O<sub>2</sub> content by volume, pressure 400 mm WC and temperature 25 °C.

### GAS COMPOSITION WITH MARINE GAS OIL (MGO)

CO < 100 ppm	NO <sub>x</sub> < 100 ppm	N <sub>2</sub> = Balance	Normal discharge pressure to cargo tank: 400 mm WC	
SO <sub>2</sub> < 1 ppm	CO <sub>2</sub> approx. 14 %		Gas outlet temperature: Max. 8 °C above seawater temperature	
Oxygen content adjustable down to 1 %			Gas outlet humidity: 100 % saturated	Fuel: MDO/ HFO/ GASOIL/ GAS

### Approvals

The Maritime Protection Inert Gas Systems are built in accordance with 1974 SOLAS Convention with latest amendments, and are fulfilling all of Class, IMO's guidelines and the demanding conditions of shipboard operation.



# DRY INERT GAS GENERATOR SYSTEM

- Easy installation and maintenance
- 100 % automatic control, no manual adjustments required by operator
- Dryer rotor will retain more than 90 % capacity after 10 years of continuous operation
- Stable dew point during operation, below -45 °C reached 20-40 minutes after start
- High grade corrosion resistant steel used for the combustion chamber

## Benefits

- Mechanically simple and reliable centrifugal blowers
- Up to 50% reduction in weight and foot-print compared to conventional systems
- Low pressure drop in system
- MODBUS, TCP/IP communication with IAS
- Modular design, dryer, cooler and heater can be separated

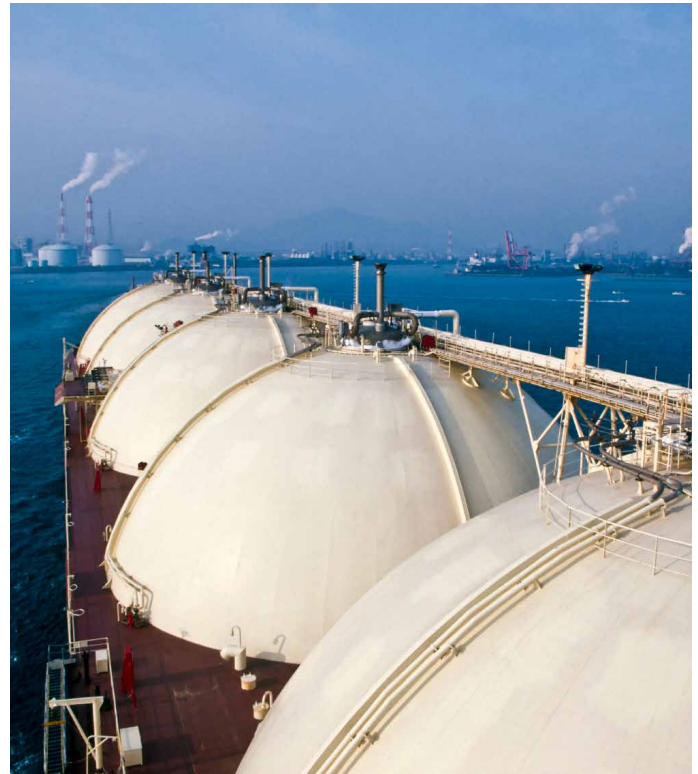

## TECHNICAL DATA

DIGG model	Capacity [Nm3/h]	Seawater Consumption [m3/h]	Fuel Consumption [kg/h]	Power Consumption [kW]	Overall System Weight [kg]
MPG - 700 - 084	900 - 2000	45 - 180	42 - 170	38 - 181	7100
MPG - 800 - 104	2000 - 3200	180 - 290	185 - 269	181 - 238	8400
MPG - 900 - 124	3200 - 4500	290 - 405	269 - 379	246 - 330	9600
MPG - 1000 - 154	4500 - 5700	405 - 510	379 - 479	335 - 387	11200
MPG - 1100 - 154	5700 - 6800	510 - 615	479 - 572	387 - 456	12600
MPG - 1300 - 174	6800 - 9500	615 - 855	572 - 800	456 - 656	14800
MPG - 1300 - 194	9500 - 10500	855 - 945	800 - 883	656 - 692	16500
MPG - 1600 - 194	10500 - 12000	945 - 1080	883 - 1010	692 - 746	21000
MPG - 1600 - 224	12000 - 16000	1080 - 1395	1010 - 1295	746 - 932	23500
MPG - 1800 - 244	16000 - 18500	1395 - 1665	1295 - 1556	932 - 1131	26600
MPG - 1800 - 264	18500 - 21000	1665 - 1890	1556 - 1766	1131 - 1365	28200

Table based on 1 % O<sub>2</sub> content by volume, discharge pressure 2500 mm WG and dew point -45 °C.

## GAS COMPOSITION WITH MARINE GAS OIL (MGO)

CO < 100 ppmv	NO <sub>x</sub> < 100 ppmv	N <sub>2</sub> = Balance	SO <sub>2</sub> < 1 ppmv	CO <sub>2</sub> approx. 14 %	O <sub>2</sub> : 0.5 - 1 %	Soot content (bacharac): 0
---------------	----------------------------	--------------------------	--------------------------	------------------------------	----------------------------	----------------------------

## Approvals

The Maritime Protection Inert Gas Systems are built in accordance with 1974 SOLAS Convention with latest amendments, and are fulfilling all of Class, IMO's guidelines and the demanding conditions of shipboard operation.



# NITROGEN SYSTEM

- Unique design for flexible installation
- Easy and reliable operation
- “State of the art”, fully automated system that protects the equipment from damage and costly repairs

## Benefits

- Long lasting and reliable system
- Flexible and space saving installation
- Predictable delivery time and time saving installation
- Easy maintenance
- Low maintenance cost

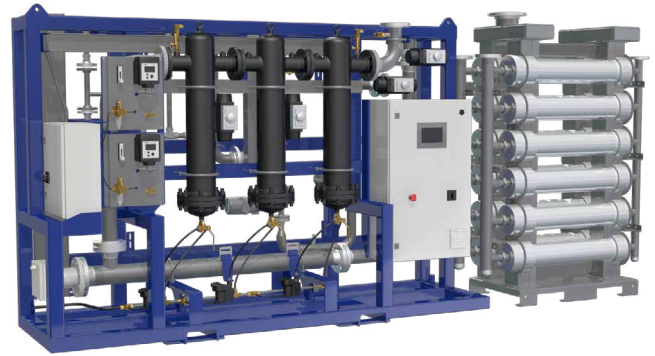

## TECHNICAL DATA

Compressors		Nitrogen Generators	
Type	Oil flooded screw compressors	Cabinets	Up to 940 Nm <sup>3</sup> /h(Q95%)
Control Method	Modulating control and variable speed drives	Open Skid Design	up to 5300 Nm <sup>3</sup> /h(Q 95%)
Pressure	8 - 14 bar(g)	Process Controlled	PLC
Cooling	Air, Fresh or sea water cooled	Ambient Temperature	3 - 55 °C
Power Consumption	35 kW per 100 Nm <sup>3</sup> /h (Q 95 % Nitrogen)	Pressure	7 - 14 bar
Starting Method	Star / Delta	Feed Air Temperature	Up to 60 °C

## TECHNICAL DATA

Nitrogen Specifications	
Oil Content in Product	Less than 10 ppb
Particles in Product	Max 0.01 Micron
Purity	95-99.9 % Nitrogen
Gas Outlet Dew Point	-70 °C

## TECHNICAL DATA

Type	Nitrogen Capacities* Q 95%	Feed Air Pressure [bar]	Dimension L x W x H [mm]	Weight [kg]	Dimension** Qty x L x W x H [mm]	Weight** Qty x unit
<b>Cabinet Design</b>			<b>Cabinet</b>			
IGN-CU-50	up to 50	7 - 14	1277 x 500 x 1092	230		
IGN-CU-400	50 - 450	7 - 14	1430 x 805 x 2141	450		
IGN-CU-900	450 - 940	7 - 14	1630 x 805 x 2145	730		
<b>Open Skid Design</b>			<b>Filter Skid</b>		<b>Membrane Skid</b>	
IGN-SU-1000	940 - 1315	7 - 14	2800 x 800 x 1900	1180	1 x 1565 x 665 x 2125	1 x 680
IGN-SU-2000	1315 - 2630	7 - 14	3100 x 900 x 2210	1850	2 x 1565 x 665 x 2125	2 x 680
IGN-SU-3000	2630 - 3950	7 - 14	4000 x 1100 x 2545	1930	2 x 1565 x 665 x 2125	2 x 680
IGN-SU-5000	3950 - 5265	7 - 14	4000 x 1100 x 2545	2030	3 x 1565 x 665 x 2125	3 x 680

## MARITIME PROTECTION NITROGEN SYSTEM

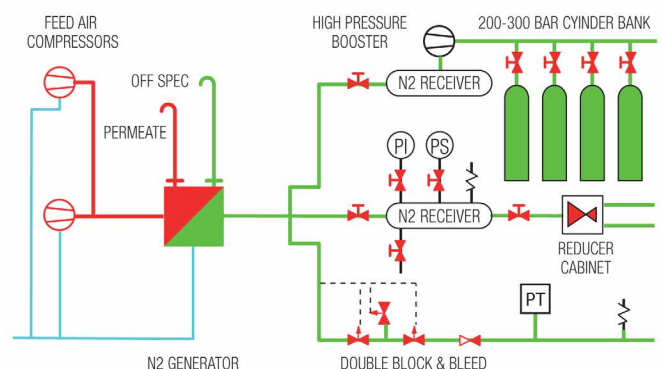

## Approvals

The Maritime Protection Nitrogen system is based on membrane technology and designed in accordance with SOLAS, IMO MODU Code and other standards for the maritime markets. It is developed to meet any offshore specifications, including NORSOK. The system is delivered with all necessary approvals.



# NITROGEN CYLINDER CENTRAL SYSTEM

- Purity range 95 - 99.996 % vol. N<sub>2</sub>
- Engineering and class approvals on request
- Clean and dry nitrogen for inerting, padding, purging and cargo change operations. Suitable for a wide range of cargo types

## Benefits

- Easy to install, operate and maintain
- Can be installed in safe or hazardous area
- No electrical power required
- Minimum space requirements
- Less maintenance



## Cylinders

### TECHNICAL DATA

Cylinder Type	N-1030	N-1050	N-5030	N-5045	N-5050
Product No	714 905 232	717 905 602	714 905 208	717 905 600	717 905 601
Purity	99.90 %	99.999 %	99.90 %	99.995 %	99.999 %
Application	Inerting				
Colour	Green	Green/Orange	Green	Green/White	Green/White
Water Capacity [L]	10	10	50	50	50
Gas Capacity [Kg]	2.3	2.3	11.5	11.5	11.5
Gas Capacity [Nm <sup>3</sup> ]	2	2	10.2	10.2	10.2
Filling Pressure [Bar]	200				
Empty Weight [Kg] appr.	18	18	81	81	81
Gross Weight [Kg] appr.	20	20	92	92	92
Overall Length [mm] appr.	1000	1000	1690	1690	1690
Outside Diameter [mm]	140	140	230	230	230
Valve Outlet Connection	W24,32 mm x 1/14" for all Nitrogen purities				
Valve Type	Forged brass with bursting disc, inlet filter and positive pressure cartridge.				

## Approvals

The Survitec Nitrogen Cylinder system can satisfy IMO International Code for the Construction and Equipment of Ships Carrying Dangerous Chemicals in Bulk (IBC Code) and International Code for the Construction and Equipment of Ships Carrying Liquefied Gases in Bulk (IGF Code), which means will be suitable for all ship applications referring to chemical, offshore supply vessels and LNG Dual Fuel.

## System arrangement

### TECHNICAL DATA

Manifolds	<ul style="list-style-type: none"> <li>• Nominal working pressure 200 bar</li> <li>• DN 12</li> </ul>
Fasteners	Racks for 1 cyl./ 2 cyl. / 4 cyl. and more if necessary
High pressure Hoses	<ul style="list-style-type: none"> <li>• Normal working pressure 200 bar</li> <li>• Test pressure 300 bar</li> <li>• 1/4" BSP</li> </ul>
Non-return Valves	1/4" BSP
Reduction Station	Pressure outlet 7-10 bar/ ~0.15 bar

# FLUE GAS SYSTEM

- Flue gas from ship's boilers are used to produce clean and soot free inert gas
- Efficient cooling by pre-cooler and scrubber tower
- High pressure centrifugal blowers positioned downstream from the flue gas scrubber provide inert gas to cargo tanks

## Benefits

- System capacity is automatically controlled by deck pressure set-point in software
- Deck Water Seal ensures safe sealing of inert gas and prevents back flow of cargo gases to safe area
- A Pressure Vacuum Breaker Protects the cargo tanks from dangerous pressure conditions



## TECHNICAL DATA

DIGG model	Capacity [Nm <sup>3</sup> /h]	Height [mm]	Length [mm]	Width [mm]	Weight [kg]
FGS 1000	2,000 - 5,000	4,100	1,950	1,000	2,000
FGS 1400	5,000 - 10,000	4,450	2,510	1,400	2,550
FGS 1600	10,000 - 15,000	4,600	2,830	1,600	2,900
FGS 2000	15,000 - 23,000	5,000	3,740	2,000	3,300
FGS 2200	23,000 - 28,000	5,000	4,300	2,200	5,000

Table based on 1 % O<sub>2</sub> content by volume, discharge pressure 2500 mm WG and dew point -45 °C.

## GAS COMPOSITION WITH MARINE GAS OIL (MGO)

SO <sub>2</sub> < 150 ppm	N <sub>2</sub> = Balance	NO <sub>x</sub> < 100 ppm	CO <sub>2</sub> approx. 14 %	Gas outlet humidity: 100 % saturated	Gas outlet temperature: Max 5 °C above seawater temperature	Soot content (bacharac): 0
---------------------------	--------------------------	---------------------------	------------------------------	--------------------------------------	---	----------------------------

Oxygen content about 3 %, dependent on Flue gas available.

## Approvals

The Maritime Protection Inert Gas systems are built in accordance with 1974 SOLAS Convention with latest amendments, and are fulfilling all of Class requirements, IMO guidelines and the demanding conditions of shipboard operation.



# AC/OX GAS DISTRIBUTION SYSTEM

- Cylinders and accessories are subject to less physical damage
- Location of cylinders is known to everyone on board
- Cylinders can easily be removed in case of a fire on board
- Gas is available simultaneously from several cylinders when needed
- Sufficient gas flow for all welding / heating / cutting purposes

## Benefits

- No interruptions during work due to change of cylinders
- Gas pressure adjustment at the outlet station, shorter hoses, and no cylinder transport to the worksite
- The total number of cylinders on board is reduced
- Regulators, flashback arrestors and hoses
- Improves work efficiency and protects the crew members from long exposure to the physical hazards of transporting steel cylinders, which can weight up to 100 kilos

## Approvals

BV, ISO14113, ABS PDA Certificate



## Ordering Information

SYSTEM	
Product Number	Central Installation Type
233064	Central Installation for 1 Acetylene + 1 Oxygen
511170	Central Installation for 1 Acetylene + 2 Oxygen
234849	Central Installation for 2 Acetylene + 2 Oxygen
510578	Central Installation for 2 Acetylene + 4 Oxygen

\* The centrals do not include oxygen flashback arrestor 85-10 (682427)

## Ordering Information

GAS OUTLET STATION	
Product Number	Model 700
550277	Steel Outlet Station Cabinet R-700 Complete with Sg-5
550335	Steel Cabinet for Outlet Station R-700
536805	Fibreglass Cabinet for Outlet Station R-700
782311	Stainless Steel Outlet Station Cabinet R-700 Complete with Sg-5
Product Number	Spares
550202	Working Pressure Gauge, Acetylene
550194	Working Pressure Gauge, Oxygen

SPARES FOR REGULATORS	
Product Number	Central Installation Type
550202	Working Gauge, Acetylene
550186	Contents Gauge, Acetylene
550194	Working Gauge, Oxygen
550178	Contents Gauge, Oxygen

## Accessories

Product Number	Product Name
510031	Regulator 530 Ox Pressure 0-10 Bar*
510030	Regulator 530 Ac Pressure 0-1.5 Bar*
510020	Regulator 520 Ac Pressure 0-1.5 Bar*
621573	Ox Low Press.Connector W/Prew.Union*
621565	Ac Low Press.Connector W/Prew.Union*
585372	Flashback Arrestor Ac 8510*
682427	Flashback Arrestor Ox 8510*
305292	High Press.Hose Ox 1 Mtr And Cable*
520403	High Press. Hose Ac 1 Mtr And Cable*
550319	Twin Valve Unit F/Outlet*

SYSTEM EXPANSION SETS	
Product Number	Central Installation Type
537217	Expansion Set, for 1 AC Cylinder
537225	Expansion Set, for 1 OX Cylinder

SIGNS	
Product Number	A. Signs for entrance doors (mm, HxW)
526533	S1. Acetylene (100x500)
526541	S2. Oxygen (100x500)
183202	S3. Gas Under Pressure (250x450)
526566	S4. Gas danger Small (150x300)
516625	Gas Danger Large (300x600)
526558	S5. No Admittance (200x500)
Product Number	B. Instruction signs for gas central
176404	S6. Acetylene Instruction (350x300)
176412	S7. Oxygen Instruction (350x300)
183236	S8. Pipeline Pressure (190x145)
Product Number	C. Signs for outlet station
183244	S9. Close Valves (90x75)
511253	S10. Working Pressures (70x200)

NOTE: The «Gas danger» small sign shall be placed at the outlet point of the ventilation pipes from the central regulators.

# SAMPLE EXTRACTION SMOKE DETECTION SYSTEM

- Automatic air sampling and monitoring of up to 48 cargo holds simultaneously
- Utilises existing CO<sub>2</sub> pipework
- Completely automated and self-adjusting
- Explosion protected to IEC79 and EN 50 020

## Benefits

- Fans switch automatically every 24 hours to give even load on motors
- Repeater panels allow for monitoring from key locations on board
- One button control for simple testing and resetting
- Cost efficient, compact and modular design

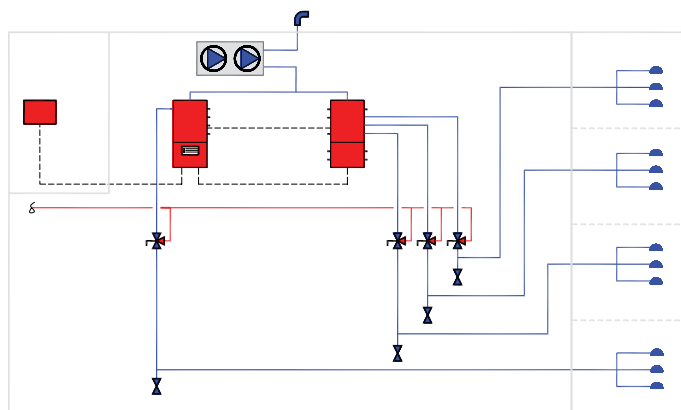

## Smoke detection panel

### TECHNICAL DATA

Smoke detection panel consist of main control panel and display with built in from 1 up to 12 detection line depending on application.

Enclosure type IP66

## Extension panel

### TECHNICAL DATA

Extension panel in various combination is used when required detection line is from 12 up to 48 detection lines

Enclosure type IP66

## Repeater panel

### TECHNICAL DATA

Repeater panel for wall mounting

Repeater panel for console mounting

Enclosure type IP65

## Fan unit

### TECHNICAL DATA

Repeater panel for wall mounting

Repeater panel for console mounting

Enclosure type IP65

## Approvals

SOLAS chapter II -2, FSS code chapter 10 MSC292, Explosion protected to IEC 79 and EN 50 020



# PERSONAL PROTECTION

**KEEPING CREW AND PASSENGERS SAFE IS THE NUMBER ONE PRIORITY WHILST AT SEA.**

Accidents cannot be prevented, but how we protect ourselves from short and long-term injury is a crucial element in today's working environment. Therefore, Survitec have set up and built relationships over a number of years, with some of the world's leading personal safety equipment suppliers to ensure you, the customer, can be supplied with our broad range of key products within this category in order to meet your safety equipment needs. Where required, our equipment includes spare parts to ensure that levels of safety are not compromised when faced with damage, misuse, loss or wear and tear.





# PORTABLE GAS DETECTION

## T4 GAS DETECTION UNIT

- Integral rubber boot extremely rugged
- Light weight
- Simple one button operation
- Visual, audible and vibrating alarm
- 4 Sensors for 4 gases
- Unit built in prevention for overexposure to toxic gases
- 24 Hour run time 5.5 Hour recharge
- Data & event logging
- Clear screen with 180 flip for easy viewing
- Easy solutions for bump test and calibration
- A hand-pump can be used for pre-entry checking, with up to 20 m sampling hose



### Ordering Information

Product Number	Product Name
778964	T4 4 Gas Detector with Sensor Guard*
778984	20 m Hose and Handpump (T4 Aspirator Kit)

### Included in 778964

- 778982 T4 power supply for cradle charger (Multi Regi Power supply unit)
- 778932 Charging cradle
- 778934 Bump/calibration plate
- 778976 Sensor filter plate
- Declaration of Conformity
- Calibration report
- Quick start guide

### APPROVALS

EMC Directive 2014/30/EU, ATEX, EMC, IECEx, UL, INMETRO



### Self-Service Kit

Product Number	Product Name
778962	T4 Service Offer

### TECHNICAL DATA

Gases Measured	Oxygen, Flammable gases or vapours, Hydrogen Sulphide and Carbon Monoxide according to SOLAS requirement. Other gases are optional.
Durability	Drop 4 M (IP 67 and IP 65)
Battery	Li-Ion
Battery Life	24 h
Recharge Time	5.5 h
Display	Front mounted, backlit, 180° flip
Alarms Audible	>95 dB
Alarm Light	Red / Blue with vibrate alert
Dimensions (h x w x d)	135 x 80 x 35 mm
Weight	282 kg

### Accessories

Product Number	Product Name
620013	Regulator for 34 L span gas cylinder (Stainless steel)
742951	Gas 34 L disposable 4-MIX 100 ppm CO, 15 ppm H <sub>2</sub> S, 2.2% CH <sub>4</sub> , 18% O <sub>2</sub>
656843	Telescopic Aspirator Probe 1 M
656835	1 m standard hose (includes tube insert)
656819	10 m standard hose (includes tube insert)
656827	20 m standard hose (includes tube insert)
778948	Gas Pro and T4 USB Cable

### Spares

Product Number	Product Name
778956	T4 Sensor Replacement Kit
778940	Tube Insert (connection from tube to flow plate) 10 Pieces
778938	Elbow Tube Insert (connection from tube to flow plate) 10 Pieces
778936	T4 Hand Aspirator Bulb
778932	Charging Cradle for T4
778982	T4 Power supply for Cradle Charger
778934	Bump/Calibration Plate for T4
778976	Sensor Filter Plate for T4

# GAS PRO 4 GAS DETECTOR

- Measures 4 gases
- Can pump with up to 30,0 meters sampling hose
- Full data/event logging for record keeping
- Robust unit for harsh environments ip65 & ip67
- One button for ease of use
- Top mount display for quick decision making
- Clear display with dual colour backlight
- Front, top and side visible alarm windows
- Four sensor apertures
- Large resonant sound cavity for ultra-loud audible alarm
- Easy solutions for bump test and calibration



## APPROVALS

EMC Directive 2014/30/EU, ATEX, IECEx, UL, INMETRO



## Ordering Information

Product Number	Product Name
778972	Gas-Pro Gas Detector with built in pump and sensor guard*

## Included in 778972

- 778944 Pumped flow plate, also for bump test, not for calibration
- 778950 Power cable (Charging lead)
- 778952 GAS-PRO MULTI REGION POWER SUPPLY
- Declaration of Conformity
- Calibration report
- Quick start guide
- CD Containing operation manual

## Self-Service Kit

Product Number	Product Name
778962	Gas Pro Service Offer

## Accessories

Product Number	Product Name
620013	Regulator for 34 L span gas cylinder (Stainless steel)
742951	Gas 34 L disposable 4-MIX 100 ppm CO, 15 ppm H <sub>2</sub> S, 2.2% CH <sub>4</sub> , 18% O <sub>2</sub> *
778946	Gas-Pro Charging Cradle (No power, need power supply)
656843	Telescopic Aspirator Probe 1 m
656835	1 m standard hose (includes tube insert)
656819	10 m standard hose (includes tube insert)
656827	20 m standard hose (includes tube insert)
778942	30 m standard hose (includes tube insert)
778948	Gas Pro and T4 USB Cable
778980	Calibration Flow Plate for PC Calibration for Gas-Pro TK and Gas-Pro (no magnet)

## TECHNICAL DATA

Gases Measured	Oxygen, Flammable gases or vapours, Hydrogen Sulphide and Carbon Monoxide according to SOLAS requirement. Other gases are optional.
Durability	Drop from 4 m and tested to IP65 and IP67
Battery	Li-Ion
Battery Life	13 h
Recharge Time	7.5 h
Display	Top mounted, Backlit
Alarm	Audible >95 db
Alarm Light	Red / Blue
Vibrate Alert	Yes
Size H x W x D	135 mm x 84 mm x 43 mm
Weight	340 g

# GAS-PRO TK GAS DETECTOR

- Measures 4 gases
- Can pump with up to 30,0 meters sampling hose
- Measures any mixtures with oxygen in the tank, down to no oxygen present, due to ir sensor
- Full data/event logging for record keeping
- Robust unit for harsh environments ip65 & ip67
- One button for ease of use
- Top mount display for quick decision making
- Clear display with dual colour backlight
- Front, top and side visible alarm windows
- Four sensor apertures
- Large resonant sound cavity for ultra-loud audible alarm
- Easy solutions for bump tests



## APPROVALS

EMC Directive 2014/30/EU, ATEX, EMC, IECEx, UL, INMETRO



## Self-Service Kit

Product Number	Product Name
778962	Gas-Pro TK Service Offer

## TECHNICAL DATA

Gases Measured	Oxygen, Flammable gases or vapours, Hydrogen Sulphide and Carbon Monoxide according to SOLAS requirement. Other gases are optional.
Durability	Drop from 4 m and tested to IP65 and IP67
Battery	Li-Ion
Battery Life	13 h
Recharge Time	7.5 h
Display	Top mounted, Backlit
Alarm	Audible >95 db
Alarm Light	Red / Blue
Vibrate Alert	Yes
Size H x W x D	130 mm x 84 mm x 43 mm
Weight	340 g

## Ordering Information

Product Number	Product Name
731508	Gas-Pro TK with built in pump Methane O <sub>2</sub> , CO, H <sub>2</sub> S
731504	Gas-Pro TK with built in pump Butane O <sub>2</sub> , CO, H <sub>2</sub> S

## Included in 731508 and in 731504

- 778944 Pumped flow plate, also for bump test, not calibration
- 778950 Power cable (Charging lead)
- 778952 Gas-Pro Multi Region Power Supply
- Declaration of Conformity
- Calibration report
- Quick start guide
- CD Containing operation manual

## Accessories

Product Number	Product Name
620013	Regulator for 34 L span gas cylinder (Stainless steel)
<b>742951</b>	<b>Gas 34 L disposable 4-MIX 100 ppm CO, 15 ppm H<sub>2</sub>S, 2.2% CH<sub>4</sub>, 18% O<sub>2</sub>*</b>
778946	Gas-Pro Charging Cradle (No power, need power supply)
656835	1 m standard hose (includes tube insert)
656819	10 m standard hose (includes tube insert)
656827	20 m standard hose (includes tube insert)
778942	30 m standard hose (includes tube insert)
778948	Gas Pro and T4 USB Cable
778980	Calibration Flow Plate for PC Calibration for Gas-Pro TK and Gas-Pro (no magnet)

# 4 COMPONENT MIX

- Disposable can
- Gas contents: 34 litres
- The connection is C10 5/8"-18 UNF
- Available in 2 solutions

## 34 L cylinder gas composition solution 1:

100 ppm Carbon monoxide (CO), 15 ppm Hydrogen Sulphide (H<sub>2</sub>S), 2.2% Methane (CH<sub>4</sub>), 18% Oxygen (O<sub>2</sub>), Balance is Nitrogen (N<sub>2</sub>)

## 34 L cylinder gas composition solution 2:

100 ppm Carbon monoxide (CO), 15 ppm Hydrogen Sulphide (H<sub>2</sub>S), 2.5% Methane - 50% LEL (CH<sub>4</sub>), 18% Oxygen (O<sub>2</sub>), Balance is Nitrogen (N<sub>2</sub>)

### APPROVALS

EMC Directive 2014/30/EU, ATEX, IECEx, UL, INMETRO



### Ordering Information

Product Number	Product Name
742951	Gas 34 L disposable 4-MIX 100 ppm CO, 15 ppm H <sub>2</sub> S, 2.2% CH <sub>4</sub> , 18% O <sub>2</sub> *
758722	4-MIX 100 CO 15 H <sub>2</sub> S 50LEL CH <sub>4</sub> 18 OX*

### Accessories

Product Number	Product Name
620013	Regulator for 34 L span gas cylinder (Stainless steel)

# OCENCO EEBD

- Used for emergency escape from any confined spaces
- Closed circuit compressed O<sub>2</sub> system
- No annual service required, 15-year life cycle
- Supplied in orange storage case
- Quick, easy use
- Low lifecycle cost
- Belt wearable
- Full visibility
- Teflon® hood and breathing bag provide excellent heat and chemical resistance

### TECHNICAL DATA

Size	170 x 170 x 76 mm
Weight	1.4 kg
Minimum Usage Time	15 Minutes
Maximum Usage Time	32 Minutes
Donning Time	<10 Seconds
Storage Temperature	-20 ° C to 65 ° C
Service Cycle	15 Years
Oxygen Delivery System	Automatic on, compressed oxygen, demand regulated
Inspection	Annual visual for stored units



### Ordering Information

Product Number	Product Name
735032	M-20.2 EEBD Breathing Device Ocenco
735040	M-20.2t Maritime Training Package Ocenco
735036	Bracket for M20.2 EEBD Ocenco

### Accessories

Product Number	Product Name
643102	M-20.2T Mouthpiece Assembly
643103	M-20.2T Trainer Mouthpiece (Quantity 10)
648000	M-20.2T Secondary Container Orange
648051	M-20.2T Secondary Container Blue

### APPROVALS

EC type Examination certificate by ABS (MED), SOLAS, Personal Protective Equipment, PPE 8, Pressure Equipment Directive, PED Modules B and D



# BREATHING APPARATUS CABINETS

- IP56 rated (IP54 rated for SOS100 and SOS923BA)
- Manufactured to be ideal for industrial, commercial and marine use
- Off-the-shelf cabinets that hold single escape sets and one or two full duration breathing apparatus sets
- Fire retardant
- Lloyds Register Type Test Approved
- Lightweight for easy attachment to walls and applications



## Ordering Information

Product Number	Product Name
1097324	JB83BA Breathing Apparatus Cabinet
FFCABJB54BA	JB54BA Breathing Apparatus Cabinet
FFCABJB08BA	JB08BA Breathing Apparatus Cabinet
FFCABSOS923BA	SOS923BA SCBA Cabinet
FFCABJB81BA	JB81 EEBD Cabinet
638395	SOS100 Emergency Escape Set Cabinet

# S-CAP ESCAPE HOOD

- Bright yellow hood fitted with a wide lens
- Nose cup gives a perfect adaptation to a wide variety of head and face sizes
- multi-purpose filter with a broad protection range including carbon monoxide

## BENEFITS

- Adjustable head harness located on the outside of the hood is directly attached to the nose cup
- The hood material, as well as the harness and the lens, are resistant against heat and short flame contact
- S-CAP is protected and stored in a vacuum-sealed aluminised foil bag
- Maintenance-free for 4 years. Thereafter, testing is required. The maximum shelf life is 10 years.



## TECHNICAL DATA

Hood Material	Coated PVC
Neck Seal	Cotton
Lens	PET
Inner Mask	NR Natural Rubber, Grey
Filter	CO, gases from fire and P2
Weight	630 g
Service Time	Minimum 15 minutes
Inhalation Resistance	1.2 mbar
Exhalation Resistance	0.5 mbar

Approvals  
EN 403: 2004

## Ordering Information

Product Number	Product Name
613874	S-CAP Escape Hood in Pouch
613875	S-CAP Escape Hood in Wall Box

# COMPRESSED AIR BREATHING

## SPIROSCOPE (EEBD)

- Used for emergency escape from any confined spaces
- Low service cost, no preventive maintenance required
- Unique patented automatic ambient air valve
- Unique patented air supply system in the hood
- Two-layered hood, outer and inner
- Very flexible neck seal
- Quiet air delivery system
- Fail safe quick start mechanism
- Compressed breathing air technology
- Quick fill system
- Available with NIOSH approval (USA) on request



### Approvals

EC type Examination certificate by DNV-GL, Directive 2014/90, on maritime equipment (MED/3.41 Emergency escape breathing devices (EEBD))

SOLAS 74 as amended, Regulation II-2/13, FSS Code 3 and IMO MSC/Circ. 849 Tested according to EN1146 ISO 23269-1:2008

Personal Protective Equipment, PPE 89/686/EEC, Article 11B tested to EN1146 Pressure Equipment Directive, PED Modules B and D

USA: 42 CFR, subpart 84 (NIOSH)



### Ordering Information

Product Number	Product Name
731491	Spiroscope EEBD Filled with Air*
613783	Spiroscope EEBD without Air
95300-12	Spiroscope EEBD Filled NIOSH Approved

### Accessories

Product Number	Product Name
613714	Hood Assembly for Escape 15N En
628164	EEBD Wall Bracket Set
638395	EEBD Cabinet
613715	Complete Regulator
591305	Hose Assembly
613719	Hose Assembly 15H
607950	Filling Adapter for Using Air Compressor Refilling

### Cylinder

Volume	Pressure	Duration	Material
3 L	200 bar	15 min	Steel /Composite
210 Cubic Inch	3000 psi	15 min	Steel /Composite

### Service requirement

No preventive maintenance on the mask, cylinder inspection after 5 years

### TECHNICAL DATA

Outer Hood Material	Coated PVC, fluorescent yellow
Inner Hood Material	Spandex
Inner Mask Material	Natural rubber
Visor Material	Surface treated PVC
Neck Seal Material	Silicone
Breathing Hose Material	Wire reinforced PVC
Carrying Bag Material	PVC coated polyamid
Dimensions (h x w x d)	500 x 230 x 130 mm
Weight Filled	5.5 kg
Weight Unfilled	4.8 kg
Inner/Outer Mask	>450 / >650 Litres per minute
Medium Pressure Range	5 – 11 bar

# SPIROMATIC 90U

## BREATHING APPARATUS

- Open back plate for good ventilation and low weight
- Easy to handle and adjustable cylinder strap
- Carrying handle integrated in backplate
- Well-proven pneumatics and robust design
- First breath activation of positive pressure or Ambient air hatch for standby use
- Excellent breathing performance
- Breathing valve is activated from inner mask
- Mask and breathing valve in a compact design
- Audible alarm placed on chest - starts at 55 +/- 5bar
- Available with extra air connection
- Spiromatic 90USA is available on request, with NIOSH approval



### TECHNICAL DATA

<b>Mask Body</b>	Natural Rubber
<b>Inner Mask</b>	Natural Rubber
<b>Visor</b>	Heat Resistant Polycarbonate
<b>Breathing Valve</b>	Heat Resistant Polyamide
<b>Membrane</b>	Natural Rubber
<b>Mask Weight</b>	0.7 kg
<b>Cylinder</b>	Steel
<b>Pressure</b>	300 bar
<b>Dimensions</b>	200 x 600 x 300 mm
<b>High Pressure Hoses</b>	Tefsel over stainless steel
<b>Medium Pressure Hoses</b>	EPDM
<b>High Pressure Parts</b>	Nickel/Chromium Plated Brass
<b>Backplate</b>	Heat Resistant Polymer
<b>Webbing</b>	Nylon
<b>Dimensions (h x w x d)</b>	200 x 570 x 280 mm
<b>Weight</b>	4.5 kg

### Ordering Information

Product Number	Product Name
<b>731429</b>	<b>SCBA Spiromatic 90U S-Mask First Breath*</b>
731435	SCBA Spiromatic 90U S-Mask First Breath Extra Air Connection
731439	SCBA Spiromatic 90U S-Mask Ambient Air Hatch
731459	SCBA Spiromatic 90U S-Mask Ambient Air Hatch Extra Air Connection

### Accessories

Product Number	Product Name
32382-03	Evac Hood with 1.5 m Hose with Euro Female Coupling, with Bag
690610	Dust Plug
FFB/AT41	4 Tally BA Control Board
FFB/AT121	12 Tally BA Control Board
FFB/ATALL	BA Control Board Tallies

### TECHNICAL DATA

	Steel Cylinder with Operating Valve	Composite Cylinder with Operating Valve	Steel Cylinder with Excess Flow Valve	Composite Cylinder with Excess Flow Valve
<b>Working Pressure</b>	300 Bar	300 Bar	300 Bar	300 Bar
<b>Water Volume</b>	6.0 litre	6.8 litre	6.0 litre	6.8 litre
<b>Air Capacity</b>	1800 litres	2040 litres	1800 litres	2040 litres
<b>Weight</b>	9.3 Kg	4.0 Kg	9.4 Kg	4.1 Kg
<b>Diameter</b>	140 mm	165 mm	140 mm	165 mm
<b>Length with valve</b>	580 mm	525 mm	580 mm	525 mm

## S-Mask First Breath



## S-Mask Ambient Air

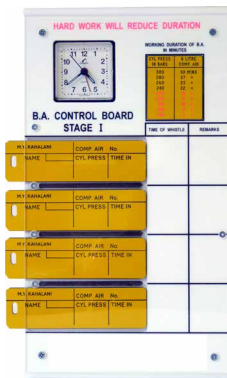

### BA CONTROL BOARD

- A high level control for wearers of breathing apparatus in hazardous conditions is of utmost importance in order to ensure their safety!

### Approvals

EC type examination certificate by DNV-GL, Marine Equipment Directive 2014/90, MED/3.7 plus MED/7.1 (entry and work in gas-filled space)

SOLAS 74 as amended, Regulation II-2/10 & X/3, 2000 HSC Code 7, FSS Code 3, IBC Code 14, IGC Code 14 and IMO MSC.1/Circ.1499

Tested according to EN 136:1998 including AC:2003 (Class 3), EN 137:2006 (Type 2), ISO 23269- 2:2011 and ISO 23269-3:2011

Personal Protective Equipment, PPE 89/686/EEC, Article 11B, Tested according to EN 136:1998 including AC:2003 (Class 3), EN 137:2006 (Type 2),

Pressure Equipment Directive, Modules B and D

USA: 42 CFR, subpart 84 (NIOSH) - 90

USA with CGA connector



### Spares

Product Number	Product Name
31821-01	S-Mask with Breathing Valve First Breath Version (Standard Size)
31820-01	S-Mask with Breathing Valve Ambient Air Version (Standard Size)
314864	Head Harness
590679	High Pressure Hose
590711	Pressure Gauge
522086	Cylinder Test Gauge
590752	Pressure Regulator R-402 F/S. Air
533521	Neck Strap for Mask
590760	Med Pressure Hose 135/16
590604	Cylinder Strap
532028	Harness for Spiromatic
532929	Breathing Hose
537191	Air Hose 15 m with Coupling
590554	Buckle Male for Harness Assembly
590562	Shoulder Strap Lower Part
98 831-03	Complete valve with EFV fitted
690453	Steel Cylinder with Operating Valve with Air
690461	Steel Cylinder with Operating Valve without Air
690454	Steel Cylinder with Excess Flow Valve with Air
690462	Steel Cylinder with Excess Flow Valve without Air
739961	Composite Cylinder with Operating Valve with Air
739979	Composite Cylinder with Operating Valve without Air
739962	Composite Cylinder with Excess Flow Valve with Air
739980	Composite Cylinder with Excess Flow Valve without Air



# BREATHING AIR COMPRESSORS

## POSEIDON AIR COMPRESSOR

- Complete, ready to use, only connect power, as illustrated
- 200 bar or 300 bar filling
- Long life Triplex P11 filter cartridges ensures cleaner air (EN12021)
- Highly engineered, robust and light weight

### BENEFITS

- Triplex filters ensure you a safe source of clean breathing air consistently
- B-timer for scheduled maintenance and running hours log can be ordered. This secures the air quality level
- The corrosion resistant steel frames make it ideal for use onboard vessels
- We have a 20 year spare parts supply and global technical service supporting your investment long term

### Included With The Compressors

#### 646034 filling valve for 200 bar with hose

##### Consist of :

**605261** Filling valve, black hand wheel with automatic vent, cylinder connection 5/8 inch BSP, DIN EN 144-2,1, and pressure gauge mounted on filling valve.

**606168** Hose 1 M, PN 450

#### 646042 filling valve for 300 bar with hose

##### Consist of:

**605253** Filling valve, red hand wheel with automatic vent, cylinder connection 5/8 inch BSP, DIN EN 144-2,1. and pressure gauge mounted on filling valve.

**606168** Hose 1 M, PN 450



### Ordering Information

Product Number	Product Name
777994	Poseidon PE100 Air Compressor 200 bar
777965	Poseidon PE100 Air Compressor 300 bar

### Accessories

Product Number	Product Name
755967	B-timer
736660	Breathing Air Compressor Quality Test Kit
528935	Compressor Filter Charge
652644	Service Kit Junior II/PE 500 H/1 Year
652651	Service Kit Junior II/PE1000 H/2 Years
736208	Service Kit Junior II/PE 2000 H/4 Years
655167	Compressor Synthetic oil 1 L
655159	Compressor Synthetic Oil 5 L
605261	Filling Valve 200 bar (Black hand wheel)
605253	Filling Valve 300 bar (Red hand wheel)
606168	Filling Hose 1 m DN5, PN450
654657	Filling Hose 3 m DN5, PN450
791619	Filling Hose 25 m DN5, PN450
758847	Filling Hose 50 m, DN5, PN450

### TECHNICAL DATA

Delivery Pressure	200 bar	300 bar
Free Air Delivery	100 l/min	
Volt / Frequency / Phase	440 v / 60 / 3	
Safety Valve	225 bar	
Power	2.2 kW	
RPM	2300	
Nos of Stages	3	
Length x Width x Height	66 x 35 x 42 cm	
Weight	44 kg	

### Approvals

TÜF EC-Conformity declaration

# JUNIOR II-E AIR COMPRESSOR

- 200 bar, 300 bar or 200/300 bar
- Complete compressor with electric connecting box
- Long life Triplex P21 Filter cartridges ensures cleaner air (EN12021)
- Highly engineered, robust and lightweight

## Benefits

- Triplex filters ensure you a safe source of clean breathing air consistently
- B-timer for scheduled maintenance and running hours log can be ordered. This secures the air quality level
- The corrosion resistant steel frames make it ideal for use onboard vessels
- We have a 20 year spare parts supply and global technical service supporting your investment long term



## Ordering Information

Product Number	Product Name
619387	Junior II-E Air Compressor 200 bar
619395	Junior II-E Air Compressor 300 bar
<b>619403</b>	<b>Junior II-E Air Compressor 200/300 bar*</b>

## TECHNICAL DATA

<b>Delivery Pressure</b>	200 bar	300 bar	200-300 bar
<b>Free Air Delivery</b>	400/440V - 50/60 Hz 3 phase		
<b>Volt / Frequency / Phase</b>	440 v / 60 / 3		
<b>Safety Valve</b>	225 bar	330 bar	225-330 bar
<b>Power</b>	2.2 kW		
<b>RPM</b>	2300		
<b>Nos of Stages</b>	3		
<b>Length x Width x Height</b>	66 x 36 x 42 cm		
<b>Weight</b>	46 kg		

## Further Technical Data

The Junior compressor is also available in a varied range of voltages / frequencies and single / three phase on request.

## Included With The Compressors

### 646034 filling valve for 200 bar with hose consist of:

Filling valve, black handwheel with automatic vent, cylinder connection 5/8 inch BSP, DIN EN 144-2,1, and pressure gauge mounted on filling valve.

- 605261 Filling Valve 200 bar Black Hand Wheel
- 606168 hose 1 m, PN 450

### 646042 filling valve for 300 bar with hose consist of:

- 605253 Filling valve, red handwheel with automatic vent, cylinder connection 5/8 inch BSP, DIN EN 144-2,1. and pressure gauge mounted on filling valve.
- 606168 hose 1 m, PN 450

## Accessories

Product Number	Product Name
755967	B-timer
736660	Breathing Air Compressor Quality Test Kit
528935	Compressor Filter Charge
652644	Service Kit Junior II/PE 500 H/1 Year
652651	Service Kit Junior II/PE1000 H/2 Years
736208	Service Kit Junior II/PE 2000 H/4 Years
655167	Compressor Synthetic oil 1 L
655159	Compressor Synthetic oil 5 L
709139	Change Over Device 200-300 Bar
709121	Change Over Device 300-200 Bar
606168	Filling Hose 1 m DN5, PN450
654657	Filling Hose 3 m DN5, PN450
791619	Filling Hose 25 m DN5, PN450
758847	Filling Hose 50 m, DN5, PN450
605261	Filling Valve 200 bar (Black hand wheel)
605253	Filling Valve 300 bar (Red hand wheel)

## Filling assembly included with 200/300 bar compressor consist of:

- 646034 filling valve and hose 200 bar
- 646042 filling valve and hose 300 bar

## Approvals

TÜF EC-Conformity declaration

# BREATHING AIR COMPRESSOR SERVICE KIT

- Complete kit for quicker maintenance time
- Cost effective spares inventory solution

## BENEFITS

- Use of genuine spares gives increased reliability and extends the life of the compressor
- The comprehensive maintenance manual and clearly marked spares make onboard maintenance simple
- Increased efficiency of spares inventory management conditions providing you with safe operation



## Ordering Information

Product Number	Product Name
652644	Junior II-E/PE 100 Compressor Service Kit Every 500 hours or 1 year
652651	Junior II-E/PE 100 Compressor Service Kit Every 1000 hours or 2 years
736208	Junior II-E /PE 100 Compressor Service Kit Every 2000 hours or 4 years

## Approvals

TÜF EC-Conformity declaration

# BREATHING AIR COMPRESSOR B-TIMER

- Self activating mini-computer counting operating hours of compressor and calculate saturation of filter cartridge
- Records running hours

## BENEFITS

- Provides easy to read maintenance log for continual monitoring of your compressors
- Your filter cartridge is constantly monitored ensuring clean air
- The 3 year battery provides durability and with no wiring necessary you can quickly fit the B timer
- Hour meter starts automatically at compressor start
- Extremely robust for global use even under toughest ambient conditions
- Dust and splash proof, insensitive to salt, solar radiation, high humidity and sand
- The B-timer saves operating hours and maintenance intervals in its memory in case of battery exchange or longer storage without battery



## Ordering Information

Product Number	Product Name
755967	Breathing Air Compressors B-Timer

## TECHNICAL DATA

Protection Class	IP 65
Vibration	+/- 3 g in operation
Humidity	95%
Storage Temperature	-20 °C to +70 °C
Operating Temperature	0 °C to 50 °C

## Approvals

TÜF EC-Conformity declaration

# BAUER COMPRESSOR OILS

- Suitable for continuous operation
- Suitable for high environmental temperatures
- Approved for breathing air applications
- Non toxic

## BENEFITS

- It is hygroscopic for moisture absorption to lengthen the life of your filters
- Comes in a convenient handy pack size so you can perform an oil change or just a top up



## Ordering Information

Product Number	Product Name
655167	Compressor Synthetic Oil 1 L for compressor produced from September 2006 and up to now
655159	Compressor Synthetic Oil 5 L for compressor produced from September 2006 and up to now
758169	Compressor mineral oil 1 L for compressors produced from April 1999 to August 2006

## Approvals

Bauer compressor oils are CE approved

# BAUER COMPRESSOR FILTER CHARGE

- Contains activated carbon, hopcalite and molecular sieve
- Easy to handle and replace

## BENEFITS

- This filter maintains the high quality of your breathing air
- It is a quick replacement when your B Timer filter status activates
- Vacuum packed, 2 years shelf life



## Ordering Information

Product Number	Product Name
528935	Bauer Compressor Filter Charge

## TECHNICAL DATA

Standard	EN12021
Oil/Aerosols	<0.1 mg/m <sup>3</sup>
CO	< 5 ml/m <sup>3</sup>
CO <sub>2</sub>	< 500 ppm (V/V)
Water Vapour	< 10 mg/m <sup>3</sup>
Odour/Taste	Nil
SO <sub>2</sub>	< 0.1 ppm (v/v)
NO	< 0.1 ppm (v/v)
NO <sub>2</sub>	< 0.1 ppm (v/v)

## Approvals

TÜF EC-Conformity declaration

# BAUER COMPRESSOR FILLING HOSE

- Ease of use
- Robust material

## BENEFITS

- Long length and standard fittings enables you to connect the compressor with lifeboat cylinder without moving them from their location
- Fluoropolymer pricked hose withstands extreme weather conditions providing you with safe operation

## TECHNICAL DATA

<b>Operating Pressure</b>	425 bar
<b>Connection</b>	M16 x 1.5
<b>DN</b>	5 mm
<b>Outer Diameter</b>	13.3 mm
<b>Outer Layer</b>	Pricked
<b>Resistant Against</b>	Salty air, Salt water, Sun and Fuel
<b>Material</b>	Fluoropolymer
<b>Temperature Range</b>	-40 °C to + 100 °C
<b>Colour</b>	Black



## Ordering Information

Product Number	Product Name
758847	Bauer Compressor Filling Hose 50 m PN450
606168	Filling Hose 1 m DN5, PN450
654657	Filling Hose 3 m DN5, PN450 (on request)
791619	Filling Hose 25 m DN5, PN450

Approvals  
TÜF EC-Conformity declaration

# BAUER OPERATING PRESSURE CONVERSION KITS

- The hand wheel on the filling gives you a safety precaution to differentiate the pressure the compressor is set at
- The conversion kits cannot be used on Poseidon compressors

## BENEFITS

- The simple bolt on kit requires you to have no specialist knowledge to install
- Can be installed on Junior II-E compressors
- Survitec global service support gives you assurance should you need any assistance or advice



## Ordering Information

Product Number	Product Name
709121	Bauer Compressor Conversion Kit 300-200 bar
709139	Bauer Compressor Conversion Kit 200-300 bar

## Accessories

Product Number	Product Name
643544	Safety Valve 225 bar for Changeover Device
646059	Safety Valve 330 bar for Changeover Device
605261	Filling Valve 225 bar (black hand wheel)
605253	Filling Valve 330 bar (red hand wheel)
606168	Filling Hose 1 M

## Approvals

Bauer change over devices are CE approved



### 709121 Bauer Compressor conversion kit 300-200 bar:

- 528901 Switch-over device
- 643544 safety valve 200 bar for switch-over
- 606168 filling hose 1 m
- 605261 filling valve 200 bar (black hand wheel)

### 709139 Bauer Compressor conversion kit 200-300 bar :

- 528901 Switch-over device
- 646059 Safety valve 300 bar for switch-over
- 606168 filling hose 1 m
- 605253 filling valve 300 bar (red hand wheel)

# BREATHING AIR COMPRESSOR QUALITY TEST KIT

- The kit enables testing of air quality in line with EN 12021
- Can measure 4 gases simultaneously
- Ready to use
- Uses readily available testing tubes

## BENEFITS

- Our kit enables you to accurately measure carbon monoxide, carbon dioxide, water, oil and nitrous oxide levels in breathing air
- Preset settings of the flow rate for the gases to be measured enables you to use the kit instantly
- Tubes are clearly arrow marked for use with the kit giving you quick and easy to understand results

## KIT CONTENTS

- The test device consisting of pressure reducer, pressure gauge, detector tube holder
- Timer
- Flow meter
- Ceramic tube breaker included in the test tube package
- Detector tubes (package of 10) for measuring CO, CO<sub>2</sub>, Water vapor and Oil.
- The standard case contains one pack of each of the four types of detector tubes.
- In addition the case has space for storing four additional spare packages



## Ordering Information

Product Number	Product Name
736660	Breathing Air Quality Test Kit

## Accessories

Product Number	Product Name
661553	Gas Detector Tube Carbon Monoxide Airtest
661728	Gas Detector Tube Water Vapour Airtest
734723	Gas Detector Tube CO <sub>2</sub> 100-2000 ppm 10 Pieces
734715	Gas Detector Tube Synthetic Oil 0.1 - 1.0 mg/m <sup>3</sup> 10 Pieces
735373	Gas Detector Tube Nitrous Fumes 0.2-6.0 ppm 10 Pieces (Optional, not part of the kit)

## TECHNICAL DATA

<b>Operational Medium</b>	Air
<b>Max Pressure</b>	300 bar
<b>Flow Preset for CO &amp; CO<sub>2</sub> Tubes</b>	0.3 l/min
<b>Flow Preset for H<sub>2</sub>O Tubes</b>	1 l/min
<b>Flow Preset for oil Tubes</b>	2.53 l/min
<b>Flow Preset for Nitrous Gases Tubes</b>	0.3 l/min

## Approvals

The breathing air compressor test kit is CE approved



# CHEMICAL PROTECTION

## TRELICHEM LIGHT T CHEMICAL SUITS

- Lightweight
- High comfort
- Breaking Apparatus (BA) worn outside of suit
- Positive pressure suit

### BENEFITS

- You can use the Trelchem Light with most standard BA sets with supplementary air connections
- It is available in 2 sizes to give you a correct fit
- The polyamide fabric coated on both sides and gives you excellent protection against alkalis, acids, oils, alcohols and aliphatics
- You will need to notify us which type of BA sets are on board so we can advise on the correct hoses and fittings



### Ordering Information

Product Number	Product Name
538918	Trelchem Light T Chemical Suit without Hose Medium*
538926	Trelchem Light T Chemical Suit without Hose Large*

### Accessories

Product Number	Product Name
571018	Chemical Suit Safety Boots Size 42
571026	Chemical Suit Safety Boots Size 43
571034	Chemical Suit Safety Boots Size 44
571042	Chemical Suit Safety Boots Size 45
775010	Repair Kit for Trelchem F/TL Suit
749838	Chemical Suit Safety Gloves for Vps/Super/Light Trelchem Suits
605204	Trelchem Hood for BA Set Protection
749846	Gloves for Trelchem Light and Splash Chemical Suits
<b>338190164</b>	<b>Spiromatic Hose without Outlet for TS/VPS/TL (for Interspiro with Euro Connection)*</b>
34892-01	Spiromatic Hose with Outlet (T-Piece) for TS/VPS/TL (for Interspiro with Euro Connection)
538942	Spiromatic Hose Without Outlet for TS/VPS/TL (for Interspiro with IS Connection) (Use 538934 Above when out of stock)
538934	Spiromatic Hose without Outlet for TS/VPS/TL (for Interspiromatic with IS Connection)
669366	Unipack Hose without Outlet for TS/VPS/TL
669358	Unipack Hose with Outlet for TS/VPS/TL

### TECHNICAL DATA

Sizing	
Medium - Height - Chest	176-188 cm 92-100 cm
Large - Height - Chest	182-194 cm 96-104 cm
Abrasion Resistance	EN 530, Method 2
Flex Cracking	ISO 7854, Method B
Flex Cracking at -30 °C	ISO 7854, Method B
Trapezoidal Tear Resistance	ISO 9073-4
Tensile Strength	ISO 13934-1
Puncture Resistance	EN 863
Resistance to Flame	EN 13274-4, Method 3
Seam Strength	ISO 5082
Anti-static	EN 1149-3, EN 1149-5

### Approvals

EN 530, method 2, ISO 7854, method B, ISO 9073-4, ISO 13934-1, EN 863, EN 13274-4, method 3, ISO 5082, EN 1149-3, EN 1149-5

Test performed to EN 943-1:2015, EN 14325:2004 and EN 374-3



# TRELICHEM T-ET CHEMICAL SUITS

- Includes mini hood and firefighters standard boots
- High comfort
- Breathing Apparatus (BA) worn outside of suit
- Positive pressure suit

## BENEFITS

- You can use the T-ET suit with most standard BA sets with supplementary air connections
- It is available in 3 sizes to give you a correct fit
- The polyamide fabric coated with Viton and Butyl rubber gives excellent protection against acids, alkalis, solvents, petrochemicals and warfare agents
- You will need to notify us which type of BA sets are on board so we can advise as to the correct hoses and fittings



## Accessories

Product Number	Product Name
775008	Repair Kit for T-ET Super suit
739029	Repair Kit for T-ET VPS suit
571018	Chemical Suit Safety Boots Size 42
571026	Chemical Suit Safety Boots Size 43
571034	Chemical Suit Safety Boots Size 44
571042	Chemical Suit Safety Boots Size 45
749838	Chemical Suit Safety Gloves for Vps/Super/Light Trelchem
749846	Gloves for Trelchem Light and Splash Chemical Suits
338190164	Spiromatic Hose without Outlet for TS/VPS/TL (for Interspiro with Euro Connection)
34892-01	Spiromatic Hose with Outlet (T-Piece) for TS/VPS/TL(for Interspiro with Euro Connection)
538942	Spiromatic Hose Without Outlet for TS/VPS/TL (for Interspiro with IS Connection (Use 538934 Above when out of stock)
538934	Spiromatic Hose without Outlet for TS/VPS/TL (for Interspiromatic with IS Connection)
669366	Unipack Hose without Outlet for TS/VPS/TL
669358	Unipack Hose with Outlet for TS/VPS/TL

## Ordering Information

Product Number	Product Name
723031	Trelchem VPS T-ET with Mini Hood, Medium
723049	Trelchem VPS T-ET with Mini Hood, Large
<b>740530</b>	<b>Trelchem Super T-ET with Mini Hood, Medium*</b>
<b>740555</b>	<b>Trelchem Super T-ET with Mini Hood, Large*</b>
741322	Trelchem Super T-ET with Mini Hood, Extra Large

## Approvals

EN 530, method 2, ISO 7854, method B, ISO 9073-4, ISO 13934-1, ISO 13934-1, EN 863, ISO 5082, EN 13274-4, method 3



## TECHNICAL DATA

	VPS T-ET	Super T-ET
<b>Sizing</b>		
<b>Medium - Height - Chest</b>	176-188 cm 92-100 cm	176-188 cm 92-100 cm
<b>Large - Height - Chest</b>	182-194 cm 96-104 cm	182-194 cm 96-104 cm
<b>Extra Large - Height - Chest</b>	N/A	188-200 cm 100-108 cm
<b>Abrasion Resistance</b>	EN 530, method 2	EN 530, method 2
<b>Flex Cracking</b>	ISO 7854, method B	ISO 7854, method B
<b>Flex Cracking at -30 °C</b>	ISO 7854, method B	ISO 7854, method B
<b>Tensile Strength</b>	ISO 13934-1	ISO 13934-1
<b>Puncture Resistance</b>	EN 863	EN 863
<b>Seam Strength</b>	ISO 5082	ISO 5082
<b>Resistance to Ignition and Flame</b>	EN 13274-4, method 3	EN 13274-4, method 3
<b>Anti-static</b>	EN1149-5	N/A



# TRELLECHEM SPLASH 600 CHEMICAL SUIT

- Helmet with visor cap and bib
- Kit comes with suit, goggles, gloves and apron
- Gloves - Rubber gauntlet 43 cm long EN374
- Suit - Blue PVC with elasticated hood, single elasticated sleeves, elasticated single legs. polyester/nylon zip with double storm flap over. Press stud closure Size - Large chest 112 cm
- Apron - Blue PVC apron 76 x 93 cm with eyelet and tapes

## BENEFITS

- The fully approved helmet includes a visor for splash protection
- Goggles can be worn under the visor to ensure eyes are fully protected
- Protecting hands is imperative so we include gauntlets to give full hand and lower protection
- Helmet Assembly - White safety helmet to EN397 High-density polyethylene shell, low-density polyethylene head harness, acetate
- visor BS2092 Grade 2 Chemical



## Accessories

Product Number	Product Name
571018	Chemical Suit Safety Boots Size 42
571026	Chemical Suit Safety Boots Size 43
571034	Chemical Suit Safety Boots Size 44
571042	Chemical Suit Safety Boots Size 45
775010	Repair Kit for Light and Splash 600 Chemical Suits
749846	Gloves for Trellechেম Light and Splash Chemical Suits
338190164	Spiromatic Hose without Outlet for TS/VPS/TL (for Interspiro with Euro Connection)
34892-01	Spiromatic Hose with Outlet (T-Piece) for TS/VPS/TL(for Interspiro with Euro Connection)
538942	Spiromatic Hose Without Outlet for TS/VPS/TL (for Interspiro with IS Connection (Use 538934 Above when out of stock)
538934	Spiromatic Hose without Outlet for TS/VPS/TL (for Interspiromatic with IS Connection)
669366	Unipack Hose without Outlet for TS/VPS/TL
669358	Unipack Hose with Outlet for TS/VPS/TL

## Ordering Information

Product Number	Product Name
723304	Trellechেম Splash 600 Chemical Suit without Boots Medium
<b>723312</b>	<b>Trellechেম Splash 600 Chemical Suit without Boots Large*</b>

## Approvals

EN 14 605 type 4, EN 14126, EN 1149-5, and SOLAS



## TECHNICAL DATA

Height	Medium	Large
	176-188 cm	182-194 cm
Chest	Medium	Large
	92-100 cm	96-104 cm
Abrasion Resistance, Flex Tear, Tensile, Seam, Puncture	EN 14605 EN 14325	
Flex Cracking	ISO 7854, method B	
Flex Cracking at -30 °C	ISO 7854, method B	
Trapezoidal Tear Resistance	ISO 9073-4	
Resistance to Flame	EN 14116	
Anti-static	EN 1149-3, EN 1149-5	

# TRELLCHEM CHEMICAL SUIT HOOD FOR FACEMASK & BREATHING APPARATUS SET

- Gives protection to Breathing Apparatus (BA) sets
- Re-usable
- Does not impede when working

## BENEFITS

- It is fitted with a long zip on one side so you can don quickly and easily
- There are split openings on the chest to allow you to read the gauge
- The wearer's exhaled air is vented through an outlet valve in the back of the hood



## Ordering Information

Product Number	Product Name
605204	Trellechm Chemical Suit Hood

# REPAIR KITS FOR TRELLCHEM CHEMICAL SUITS

- Simple but effective small repair system
- Complete kit with patches, glue, hardener, solvent and brush

## BENEFITS

- The kit reduces your downtime for minor repairs keeping you going while at sea
- No specialist knowledge is required by your crews as the easy to follow instructions explain how to carry out repairs
- If you have any major work required we fully support your Trellechm suits through our global service network



## Ordering Information

Product Number	Product Name
739029	Repair Kit for Trellechm Vps Suit
775008	Repair Kit for Trellechm Super Suit
775010	Repair Kit for Trellechm Light and Splash 600 Suits

## TECHNICAL DATA

Material	Butyl rubber and Viton® rubber
Thickness	0.80 nominal
Length	35 cm
Colour	Black

# CHEMICAL RESISTANT CLOTHING KIT

- Helmet with visor cap and bib
- Kit comes with suit, goggles, gloves and apron
- Gloves - Rubber gauntlet 43 cm long EN374
- Suit - Blue PVC with elasticated hood, single elasticated sleeves, elasticated single legs. polyester/nylon zip with double storm flap over.
- Press stud closure Size - Large chest 112 cm
- Apron - Blue PVC apron 76 x 93 cm with eyelet and tapes

## BENEFITS

- The fully approved helmet includes a visor for splash protection
- Goggles can be worn under the visor to ensure eyes are fully protected EN1661C
- Protecting hands is imperative so we include gauntlets to give full hand and lower protection
- Helmet Assembly - White safety helmet to EN397 High-density polyethylene shell, low-density polyethylene head harness, acetate
- visor BS2092 Grade 2 Chemical



## Ordering Information

Product Number	Product Name
576843	Chemical Resistant Clothing Kit*

## Approvals

EN374, EN397, BS2092 and EN1661C



# CHEMICAL SUIT SAFETY BOOTS

- Steel toe cap and midsole
- Anti static
- Cold insulating
- Available in sizes 42 to 45
- EN 20345 type S5 HRO SRC
- EN 15090 type F3A

## BENEFITS

- Yellow to identify with chemical clothing
- Resistant to minerals, animal and vegetable oils & fats, disinfectants and various chemicals



## Ordering Information

Product Number	Product Name
571018	Chemical Suit Safety Boots Size 42
571026	Chemical Suit Safety Boots Size 43
571034	Chemical Suit Safety Boots Size 44
571042	Chemical Suit Safety Boots Size 45

## Approvals

EN 20345 type S5 HRO SRC and EN 15090 type F3A



# CHEMICAL SUIT SAFETY GLOVES

- Simple to replace on board
- Provide abrasion resistance
- Soft and flexible
- Includes the bayonet ring

## BENEFITS

- Carrying a spare set maintains operational readiness of your chemical suits
- The VPS/Super and Light bayonet system allows you to replace gloves quickly and easily
- They are soft and flexible allowing you to carry out most tasks
- These outer barrier gloves protect your hands from abrasions and ensure your suit remains gas tight



## Ordering Information

Product Number	Product Name
749838	Chemical Suit Safety Gloves
775379	Firemans Gloves Insulated

## TECHNICAL DATA

<b>Material</b>	Butyl rubber and Viton® rubber
<b>Thickness</b>	0.80 nominal
<b>Length</b>	35 cm
<b>Colour</b>	Black

Approvals  
CE 0298



# SOPEP SPILL KITS

- Range of oil spill kits for all types and size vessels
- Enables clean up of hydrocarbons, solvents and other organic liquids
- Ideal when the requirement for speed and efficiency is integral to clean-up process
- Made from 100% polyethylene allowing for storage both internally and externally
- Water-repellency exceeds requirements of BS 7959-2:2000
- Refill sets can be supplied



## Ordering Information

Product Number	Product Name
SS/0170/SOPEP1BY	Spill Kit - 1 Barrel
SS/0170/SOPEP7BY	Spill Kit - 7 Barrel
SS/0170/SOPEP12BY	Spill Kit - 12 Barrel

## TECHNICAL DATA

<b>Container size</b>	146 x 101 x 97.5 cm
<b>Container volume</b>	1000 L
<b>Container colour</b>	Yellow
<b>Sorbency</b>	1 barrel 7 barrels 12 barrels

# HEIGHT SAFETY

## FULL BODY HARNESS

- 3 Point adjustment
- Lightweight
- Rear dorsal ring connection
- Can be used with a fall prevention device
- Universal sizing allows a requirement for fewer harnesses to be carried on board a vessel
- Flexible back panel for comfort, spreading any loads
- Quick adjustment buckles for multi person usage and increased levels of comfort
- Lightweight for the wearer when climbing or carrying out high levels of exertion



**APPROVALS**  
CE marked



### Ordering Information

Product Number	Product Name
777603	Full Body Harness with Rear Attachment

### TECHNICAL DATA

Webbing	> 2500 daN
Fittings	High Strength Zinc Plate
System Breaking Strength	1500 daN
Net Weight	0.855 kg

## WORK POSITIONING SAFETY BELT

- Waist sizes up to 145 cm
- Complies with en 358
- System strength 1500 dan
- 2 Positioning rings
- Allows for a wide range of waist sizes or for multi-layer clothing in colder working conditions
- Comfort pad to give additional support whilst working
- The 1500 dan ensures performance when required
- The two positioning rings gives the wearer options for an anchoring point so as not to hamper their work



### Ordering Information

Product Number	Product Name
777604	Work Positioning Safety Belt*

### TECHNICAL DATA

Webbing Material	Polyester 45 mm
Webbing Strength	2200 DaN
Comfort Pad	Thermo compressed foam, Cotton inner lining
Buckle	High strength electro zinc plated steel
Attachment D Rings	Zinc-plated forged steel
Quick Adjustment Buckles	System breaking strength >1500 DaN Complies with standard EN 358

**APPROVALS**  
EN358



# SHOCK ABSORBING LANYARD 1.75 M



## TECHNICAL DATA

Breaking Strength	>15kN
Shock Absorbing Element	
Engaging Force	> 2 kN
Impact Force Reduction	< 6 kN
Polyester Webbing	
Width	45mm
Strength	> 2000 daN

## Ordering Information

Product Number	Product Name
SBLAN/175W	Protecta First Shock Absorbing Lanyard 1.75 m Scaffold hook
AE5220WAA	Protecta First Shock Absorbing Lanyard 2 m with 2 x Screwgate Karabina 17 mm Opening
AE529/1	Protecta First Shock Absorbing Lanyard 1.5 m with 2 x Screwgate Karabina 17 mm Opening

# REBEL SELF-RETRACTING LIFELINE

- Twist-lock zinc plated carabiner 16 kn gate strength with 18 mm opening
- Super-tough nylon housing
- Heat-shrunk clear pvc coating on shock pack
- Small opening snap hook or big opening rebar hook

Approvals  
CE EN360:2002



## TECHNICAL DATA

Webbing Material	25 mm Polyester
Cable	5 mm Diameter
Recall Sprint Material	Stainless Steel
Connection Level	Shoulder Height
Capacity	140 kg
Servicing	6 m and 4.5 m units are repairable

## Ordering Information

Product Number	Product Name
3100423	Rebel Self-retracting Lifeline 3.3 m
3100437	Rebel Self-retracting Lifeline 6 m
3590024	Rebel Self-retracting Lifeline 4.5 m Cable

# EQUIPMENT STORAGE

## CABINET FOR FIRE FIGHTERS SUIT

- Glass Reinforced Plastic (GRP) construction
- Stainless steel hinges and fittings
- Waterproof
- Clear labelling

### BENEFITS

- We offer a large capacity so you can stow multiple products if required
- Our manufacturing process and stainless steel fitting give strong colour fastness for a longer life
- Options include floor or wall mounted versions enabling you to maximise your space
- For total protection of your equipment you can choose internal fittings to be included

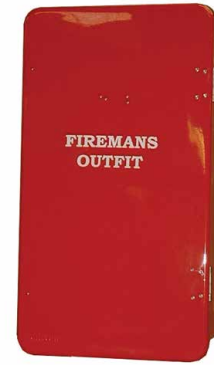

### Ordering Information

Product Number	Product Name
592576	Cabinet for Fire Fighters Outfit

### TECHNICAL DATA

Length	595 mm
Width	630 mm
Height	1120 mm
Capacity	1 Fire Fighters Suit

## CABINET FOR LIFEJACKETS

- Glass Reinforced Plastic (GRP) construction
- Stainless steel hinges and fittings
- Waterproof
- Clear labelling

### BENEFITS

- We offer a large capacity so you can stow multiple products if required
- Our manufacturing process and stainless steel fitting give strong colour fastness for a longer life
- Options include floor or wall mounted versions enabling you to maximise your space
- For total protection of your equipment you can choose internal fittings to be included



### TECHNICAL DATA

Thickness	5-6 mm GRP
Door Catch	Stainless Steel - 3-way Locking
Door Handle	Stainless Steel L Handle
Internal Depth	115 mm
Dimensions	2050 x 1435 x 1200 mm
Aperture (H x w)	1739 x 1164 mm
Door Handle	Stainless Steel L Handle
Weight	71 kg

### Ordering Information

Product Number	Product Name
JB17.1200	JB17.1200 Automatic Lifejacket Cabinet

# CHESTS FOR LIFEJACKETS/IMMERSION SUITS

- Stainless steel hinges and fittings
- Waterproof
- Clear labelling

## Benefits

- We offer a large capacity, so you can stow multiple products if required
- Our manufacturing process and stainless-steel fittings give strong colour fastness for a longer life
- Options include floor or wall mounted versions enabling you to maximise your space
- For total protection of your equipment you can choose internal fittings to be included
- Cabinets can be stacked up to 8 high for transport or when not in use



## Ordering Information

Product Number	Product Name
731510	Lifejacket/Immersion Suit Chest SOS506
731514	Lifejacket/Immersion Suit Chest SOS510
731518	Lifejacket/Immersion Suit Chest SOS516

## TECHNICAL DATA

	SOS506	SOS510	SOS516
Height x width x depth	780 x 990 x 620 mm	737 x 1030 x 982 mm	860 x 1430 x 930 mm
Weight	21 kg	27.5 kg	36 kg
IP Rating	IPX5		
Material	Rotationally moulded polyethylene		
Door Catch	Marine spec bungy cord for fast access		
Hinges	Stainless-Steel		
Optional Extras	Lettering, Sign		

# CHESTS FOR LIFEJACKETS/IMMERSION SUITS GRP

- Stainless steel hinges and fittings
- Waterproof
- Clear labelling

## Benefits

- We offer a large capacity, so you can stow multiple products if required
- Our manufacturing process and stainless-steel fittings give strong colour fastness for a longer life
- Options include floor or wall mounted versions enabling you to maximise your space



## TECHNICAL DATA

	JB72	JB73	JB74	JB75
Height x width x depth (mm)	875 x 1150 x 750	875 x 1480 x 1050	801 x 2385 x 885	900 x 2395 x 890
Weight	33 kg	39 kg	45 kg	61 kg
IP Rating	IP56			
Material	3-4mm nominal thickness GRP			
Door Catch	Protex clips			
Hinges	316 Stainless Steel 'T' hinges			
Seal	EPDM seal			

## Ordering Information

Product Number	Product Name
JB72	Lifejacket/Immersion Suit Chest Flat base
JB73	Lifejacket/Immersion Suit Chest SOS510
JB74	Lifejacket/Immersion Suit Chest SOS516
JB75	Lifejacket/Immersion Suit Chest SOS516



# PERSONAL LIFE SAVING APPLIANCES (LSA)



For Survitec saving lives is undoubtedly of paramount importance to us. Designed specifically with commercial use in mind, we have a range of both ISO and MED/SOLAS approved lifejackets to suit varying needs, including emergency passenger lifejackets.

Bladder Design Technology is of the upmost importance to us: Our expert design team constantly push the boundaries in design, keeping you up to date with the most advanced technology in lifesaving equipment.



Our expert design team  
push the boundaries in  
design



# INFLATABLE LIFEJACKETS

## SEACREWSADER 290N 3D

- Easy to replace cover system
- Waterproof service labels
- Can be used with a PLB & AIS
- 3D Cover
- High strength plastic quick release buckle
- YKK QBZ Tri-burst zip
- Foam padded cover for added protection
- Spare covers can be purchased separately including fire retardant and wipe clean options



### Ordering Information

Product Number	Product Name
1146-AUTO	Seacrewsader 290N 3D
1146-AUTOH	Seacrewsader 290N 3D Harness
1146-FRAURO	Seacrewsader 290N 3D Fire Retardant
1146-FRAUTOH	Seacrewsader 290N 3D Fire Retardant Harness
1146-WCAUTO	Seacrewsader 290N 3D Wipe Clean
1146-WCAUTOH	Seacrewsader 290N 3D Wipe Clean Harness
1383-RALJ	Seacrewsader 290N 3D Rope Access Lifejacket
1383-RALJHD	Seacrewsader 290N 3D Rope Access Lifejacket with Hood

### Spares

Product Number	Product Name
11037	60 g CO <sub>2</sub> Cylinder for 290N Lifejackets
10017	Mk5i Black Automatic Capsule
12050	60 g CO <sub>2</sub> Cylinder for Manual and Automatic
1146-COVER	Replacement Heavy Duty Cover
1146-FRCOVER	Replacement Fire Retardant Cover
1146-WCCOVER	Replacement Wipe Clean Cover

### Accessories

Product Number	Product Name
SUPFITS20	McMurdo S20 Supply and Fit
10226	CREWSAVER Surface Light - Unpackaged*

### Approvals

SOLAS 2010 regulations according to MSC 81(70) as amended by MSC 200(80) and MSC 207(81).



### TECHNICAL DATA

Newtons	290N
Type	Lifejacket
Flotation	Inflatable
Chambers	Twin
Harness	Fall Arrest / Deck Optional
Cover	Heavy Duty / Fire Retardant or Wipe Clean Optional

# SEACREWSADER 2010 275N

- Twin chamber 275N MSC 200 (80)/ SOLAS approved lifejacket
- High buoyancy level provides added protection when heavy work gear and clothing is worn
- Suitable for use with most immersion and abandonment suits, subject to compatibility testing
- One size fits all adult size
- Uses 2 x 60 g cylinders on symmetrical inflation chambers



## Ordering Information

Product Number	Product Name
1143-AUTO	Seacrewsader 275N Twin Chamber Automatic with Hood*
1143-PLUS	Seacrewsader 275N Automatic Fall Arrest Harness with Hood
1143-AUTOH	Seacrewsader 275N Automatic Hood and Harness
1154-HAMM	Crewfit 275N Hammar with Hood
1154-H&H	Crewfit 275N Hammar with Hood and Harness
1154-PLUS	Crewfit 275N Hammar with Hood and Fall Arrest Harness

## Spares

Product Number	Product Name
11037	60 g CO <sub>2</sub> Cylinder for 290N Lifejackets
10017	Mk5i Black Automatic Capsule
12050	CO <sub>2</sub> Cylinder 60 g for Manual and Automatic
11011	Hammar Rearming Kit (60g)
<b>10226</b>	<b>Crewsaver Surface Light - Unpackaged *</b>
10678	Whistle - Unpackaged

## Accessories

Product Number	Product Name
SUPFITS20	S20 Supply and Fit
SUPFIT220-C	McMurdo Fast Find 220 PLB
10065	Lifejacket Bag

## Approvals

SOLAS 2010 regulations according to MSC 81(70) as amended by MSC 200(80) and MSC 207(81).



## TECHNICAL DATA

<b>Newtons</b>	275N
<b>Type</b>	Lifejacket
<b>Flotation</b>	Inflatable
<b>Chambers</b>	Twin
<b>Harness</b>	Fall Arrest / Deck Optional
<b>Cover</b>	Heavy Duty

# CREWFIT 150N WIPE CLEAN

- The automatic 150N inflation chamber out performs approval and offers 165N of buoyancy
- Lifting becket
- Built in inflatable chin support
- Manual oral inflation tube for additional air top up
- Whistle
- Reflective tape to aid visibility
- Wipe clean cover with fabric shoulder panels for easy cleaning and comfort
- Waist adjuster
- Velcro closure system
- Supplied with dual crotch straps



## Ordering Information

Product Number	Product Name
9201WOA	Crewfit 150N Automatic Wipe Clean Orange*
9201WYA	Crewfit 150N Automatic Wipe Clean Yellow

## Spares

Product Number	Product Name
10017	Mk5i Black Automatic Capsule
12040	33 g CO <sub>2</sub> Cylinder for 150N Lifejackets

## Accessories

Product Number	Product Name
SUPFITCSL	CSL Light Supply and Fit
SUPFITHOOD150/165	Spray Hood 150N Supply and Fit
10032	Crotch Straps

## Approvals

Designed to meet ISO approval 12402-3



## TECHNICAL DATA

Newtons	150N
Type	Lifejacket
Flotation	Inflatable
Chambers	Single
Approval	ISO 12402-3

# CREWFIT 150N

- The automatic 150N inflation chamber out performs approval and offers 165N of buoyancy
- Lifting becket
- Built in inflatable chin support
- Manual oral inflation tube for additional air top up
- Whistle
- Reflective tape to aid visibility
- Waist adjuster
- Velcro closure system
- Supplied with dual crotch straps



## Ordering Information

Product Number	Product Name
9201RM	Crewfit 150N Manual Red
9201RA	Crewfit 150N Automatic Red

## Spares

Product Number	Product Name
10017	Mk5i Black Automatic Capsule
12040	33 g CO <sub>2</sub> Cylinder for 150N Lifejackets

## Accessories

Product Number	Product Name
SUPFITCSL	CSL Light Supply and Fit
SUPFITHOOD150/165	Spray Hood 150N Supply and Fit
10032	Crotch Straps

## Approvals

Designed to meet ISO approval 12402-3



## TECHNICAL DATA

Newtons	150N
Type	Lifejacket
Flotation	Inflatable
Chambers	Single
Approval	ISO 12402-3

# CREWFIT 150N HF

- Fusion 3D ergonomic shape for comfort and freedom of movement
- Compact High Fit profile for comfort
- Heavy duty 500D front body panels for maximum durability
- Lifting becket
- Indicator window
- Twin waist adjusters
- YKK quick burst zip
- Soft loop harness point
- Fitted crotch strap



## Ordering Information

Product Number	Product Name
9224RA	Crewfit 150N HF Red Automatic Harness

## Spares

Product Number	Product Name
10007	Automatic 38 g Rearming Kit
10017	Mk5i Black Automatic Capsule
12045	CO <sub>2</sub> Cylinder 38 g for Manual and Automatic

## Accessories

Product Number	Product Name
SUPFITCSL	CSL Light Supply and Fit
SUPFITHOOD150HF/180	Spray Hood 150N HF Supply and Fit
SUPFITS20	McMurdo S20 Supply and Fit

## Approvals

Designed to meet ISO approval 12402-3



## TECHNICAL DATA

Newtons	150N
Type	Lifejacket
Flotation	Inflatable
Chambers	Single
Harness	Deck
Cover	Heavy Duty
Approval	ISO 12402-3

# CREWFIT 150N XD

- Fusion 3D ergonomic shape for comfort and freedom of movement
- Heavy duty 500D cover
- Indicator window with protection panel and Hypalon retainer
- Twin waist adjusters
- YKK tri quick burst zip
- Supplied with dual crotch straps



\*Hood and light are an optional extra, see accessories ordering information



## Ordering Information

Product Number	Product Name
9241RM	Crewfit 150N XD Red Manual
9241NBM	Crewfit 150N XD Navy Manual
9241RA	Crewfit 150N XD Red Automatic
9241NBA	Crewfit 150N XD Navy Automatic
9241RH	Crewfit 150N XD Red Hammar
9241NBH	Crewfit 150N XD Navy Hammar
9245RM	Crewfit 150N XD Red Manual Harness
9245NBM	Crewfit 150N XD Navy Manual Harness
9245RA	Crewfit 150N XD Red Automatic Harness
9245NBA	Crewfit 150N XD Navy Automatic Harness
9245RH	Crewfit 150N XD Red Hammar Harness
9245NBH	Crewfit 150N XD Navy Hammar Harness

## Spares

Product Number	Product Name
10007	Automatic 38 g Rearming Kit
11320	Hammar 38 g Rearming Kit
10034	Manual 38 g Rearming Kit
10017	Mk5i Black Automatic Capsule
11104	Hammar MA1 Automatic Capsule
12045	CO <sub>2</sub> Cylinder 38 g for Manual and Automatic
12038	CO <sub>2</sub> Cylinder 38 g with back plate for Hammar

## Accessories

Product Number	Product Name
SUPFITCSL	CSL Light Supply and Fit
SUPFITHOODXD150	Spray Hood 150N XD Supply and Fit
SUPFITS20	McMurdo S20 Supply and Fit

## Approvals

Designed to meet ISO approval 12402-3



## TECHNICAL DATA

<b>Newtons</b>	150N
<b>Type</b>	Lifejacket
<b>Flotation</b>	Inflatable
<b>Chambers</b>	Single
<b>Harness</b>	Optional
<b>Cover</b>	Heavy Duty
<b>Approval</b>	ISO 12402-3

# CREWFIT 275N XD

- Fusion 3D ergonomic shape for comfort and freedom of movement
- Heavy duty 500D cover
- Indicator window with protection panel and Hypalon retainer
- Twin waist adjusters
- YKK tri quick burst zip
- Supplied with dual crotch straps



\*Hood and light are an optional extra, see accessories ordering information



## Ordering Information

Product Number	Product Name
9251RM	Crewfit 275N XD Red Manual
9251NBM	Crewfit 275N XD Navy Manual
9251RA	Crewfit 275N XD Red Automatic
9251NBA	Crewfit 275N XD Navy Automatic
9251RH	Crewfit 275N XD Red Hammar
9251NBH	Crewfit 275N XD Navy Hammar
9255RM	Crewfit 275N XD Red Manual Harness
9255NBM	Crewfit 275N XD Navy Manual Harness
9255RA	Crewfit 275N XD Red Automatic Harness
9255NBA	Crewfit 275N XD Navy Automatic Harness
9255RH	Crewfit 275N XD Red Hammar Harness
9255NBH	Crewfit 275N XD Navy Hammar Harness

## Spares

Product Number	Product Name
11037	Automatic 60 g Rearming Kit
11321	Hammar 60 g Rearming Kit
10470	Manual 60 g Rearming Kit
10017	Mk5i Black Automatic Capsule
11104	Hammar MA1 Automatic Capsule
12050	CO <sub>2</sub> Cylinder 60 g for Manual and Automatic
11034	MA1 Back Plate with Glued 60 g Cylinder

## Accessories

Product Number	Product Name
SUPFITCSL	CSL Light Supply and Fit
SUPFITHOODXD275	Spray Hood 275N XD Supply and Fit
SUPFITS20	McMurdo S20 Supply and Fit

## Approvals

Designed to meet ISO approval 12402-2



## TECHNICAL DATA

Newtons	275N
Type	Lifejacket
Flotation	Inflatable
Chambers	Single
Harness	Optional
Cover	Heavy Duty
Approval	ISO 12402-2



# FOAM LIFEJACKETS

## PREMIER COMPACT

- Efficient use of storage space at only 17.4L - 42% smaller alternative to the original premier 2010
- Easy pull-out pillow for intuitive donning
- A foam cut out for the buckle ensures easy stack-and-stow, no folding or manipulation required
- Sacrificial stitch at the end of the waist belt to allow it to run free if caught, helping to prevent snag hazards
- Improved comfort and fit around the neck with re-engineered neck aperture
- Buddy line and whistle stored in recessed pocket
- High visibility fabric, foam and webbing are a proven success in the field
- Waist belt designed to fit chest girth of 1750mm
- 2 x clear id windows for vessel identification

### Packed Jacket



### Ordering Information

Product Number	Product Name
10670	Premier Compact
12672	Premier Compact with Universal Recessed Light and Integrated Sensor*
12679	Premier Compact with Universal Surface Light and Integrated Sensor

### Accessories

Product Number	Product Name
10276	Universal Light SOLAS with Integrated Sensor and Recessed Adaptors*
10278	Universal Light SOLAS with Integrated Sensor and Surface Mount Bracket*
10032	Crotch Straps

### Approvals

MED Approved. IMO Resolution MSC.81(70), Part 1 as amended by Resolution MSC.200(80), MSC.207 (81), MSC.218 (82), MSC.323 (89) and MSC.378 (93)



### TECHNICAL DATA

Newtons	143N
Type	Lifejacket
Flotation	Foam
Approval	MED/SOLAS

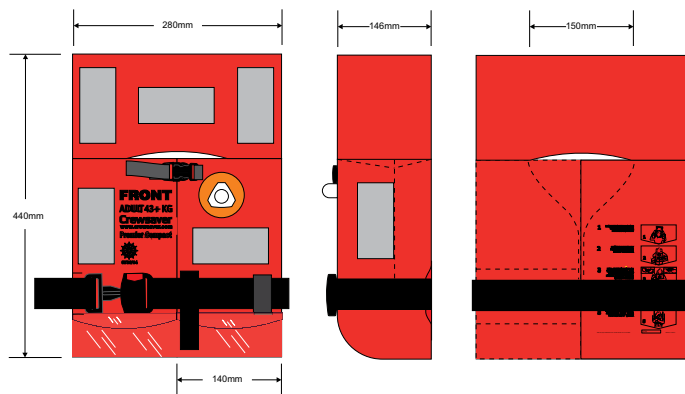

# PREMIER COMPACT CREW

- Efficient use of storage space at only 17.4L - 42% smaller alternative to the original premier 2010
- Easy pull-out pillow for intuitive donning
- A foam cut out for the buckle ensures easy stack-and-stow, no folding or manipulation required
- Sacrificial stitch at the end of the waist belt to allow it to run free if caught, helping to prevent snag hazards
- Improved comfort and fit around the neck with re-engineered neck aperture
- Buddy line and whistle stored in recessed pocket
- High visibility fabric, foam and webbing are a proven success in the field
- Waist belt designed to fit chest girth of 1750mm
- Clear id windows for vessel identification

Manufactured in a distinctive yellow colour scheme specifically for the ship's crew, allowing passengers to easily identify them in the event of an emergency.

## Packed Jacket



## Approvals

MED Approved. IMO Resolution MSC.81(70), Part 1 as amended by Resolution MSC.200(80), MSC.207 (81), MSC.218 (82), MSC.323 (89) and MSC.378 (93)



## Ordering Information

Product Number	Product Name
10671	Premier Compact Crew - Yellow
12690	Premier Compact Crew with Universal Recessed Light and Integrated Sensor - Yellow*
12691	Premier Compact Crew with Universal Surface Light and Integrated Sensor - Yellow

## Accessories

Product Number	Product Name
10276	Universal Light SOLAS with Integrated Sensor and Recessed Adaptors*
10278	Universal Light SOLAS with Integrated Sensor and Surface Mount Bracket*
10032	Crotch Straps

## TECHNICAL DATA

Newtons	143N
Type	Lifejacket
Flotation	Foam
Approval	MED/SOLAS

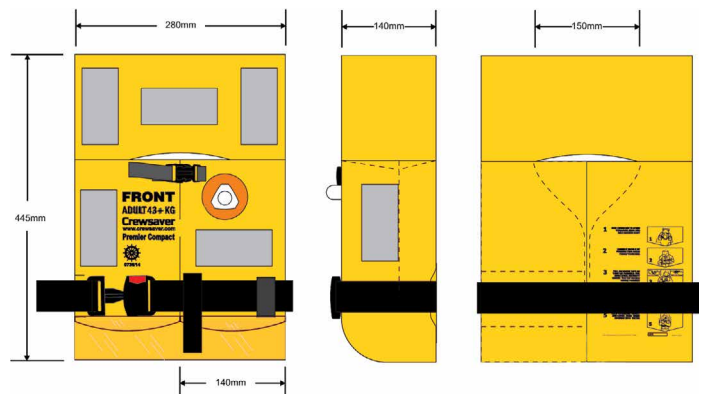

# PREMIER 2010

- MED/SOLAS approved lights
- Optional spray hood
- Available in adult, child and infant sizes
- Highly visible colour with SOLAS approved retro reflective tape
- Buddy line and whistle stored in recessed pocket
- Waist belt designed to fit chest girth of 1750 mm
- Sacrificial stitch at the end of the waist belt to allow it to run free if caught, helping to prevent snag hazards
- Yellow crew option available

## Other Size Options

### Child



\*two clear plastic zone marking inserts

### Infant



\*one clear plastic zone marking insert



## Ordering Information

PRODUCTS	
Product Number	Product Name
10572	Premier Lifejacket Adult Orange
10573	Premier Lifejacket Child Orange
10575	Premier Crew Lifejacket Adult Yellow
12610	Premier Lifejacket Adult and Universal Surface Light With Integrated Sensor
12616	Premier Lifejacket Child and Universal Surface Light with Integrated Sensor
12617	Premier Lifejacket Infant and Universal Surface Light with Integrated Sensor
12618	Premier Lifejacket Crew and Universal Surface Light with Integrated Sensor
12611	Premier Lifejacket Adult and Universal Recessed Light With Integrated Sensor
12612	Premier Lifejacket Crew and Universal Recessed Light with Integrated Sensor
12668	Premier Lifejacket Child and Universal Recessed Light with Integrated Sensor
12669	Premier Lifejacket Infant and Universal Recessed Light with Integrated Sensor

## Approvals

Designed to meet SOLAS Resolution MSC.200(80), MSC 81 (70) and MSC 2007(81)



## TECHNICAL DATA

Newtons	
Adult	>43 kg 190N
Child	15 kg to 43 kg 108N
Infant	Up to 15 kg 68N
Type	Lifejacket
Flotation	Foam
Approval	SOLAS

## Accessories

PRODUCTS	
Product Number	Product Name
10282	Universal Light SOLAS and Recessed Adaptors
10281	Universal Light SOLAS and Surface Mount Bracket
10659	Premier Spray Hood
10032	Crotch Straps
10278	Universal Light SOLAS with Integrated Sensor and Surface Mount Bracket *
10276	Universal Light SOLAS with Integrated Sensor and Recessed Adaptors *

# IMMERSION SUITS

## CREW ENDURANCE

- Unpacked and donned in under 2 minutes
- Waterproof zip and MED/SOLAS approved reflective tape
- 5mm neoprene face flap and inside chin flap for dual protection
- Fire retardant neoprene construction
- Withstands the impact of a jump into water from 4.5 m
- Prevents a typical wearer's core body temperature from dropping by more than 2 °C after six hours in calm water of 0-2 °C
- Must be worn with a lifejacket

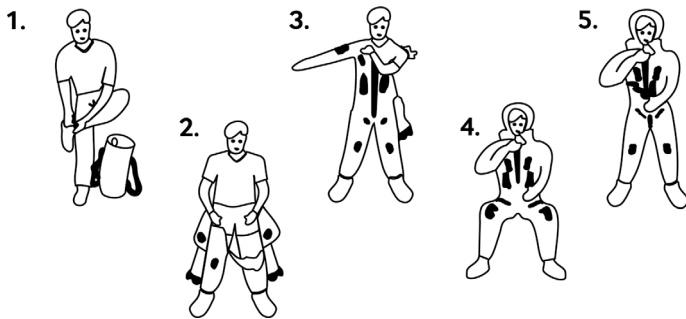

### Approvals

Approved in compliance with SOLAS 74/78 as amended Reg. 111/4, 111/7, 111/22, 111/32, 111/34, X/3. 1994 and 2000 HSC Code 8. IMO Resolution MSC.48(66)(LSA Code), II. IMO Resolution MSC 81(70) as amended by, IMO Resolution MSC 200(80), MSC 226(82), MSC323(89)



### Ordering Information

Product Number	Product Name
8810-M	Crew Endurance Immersion Suit - Medium*
8810-L	Crew Endurance Immersion Suit - Large*
8810-XL	Crew Endurance Immersion Suit - Extra Large*

### Accessories

Product Number	Product Name
1143-AUTO	**Seacrewsader 275N Twin Chamber Automatic with Hood
10220	Crewsaver Surface Light (CSL)

\*\* A number of SOLAS lifejacket options are also available

### TECHNICAL DATA

Size	
Medium	150 - 170 cm
Large	170 - 190 cm
Extra Large	190 - 210 cm
Harness	Not included
Type	Immersion Suit

# CREW ENDURANCE 140N

- Buoyancy pillow
- Unpacked and donned in under 2 minutes
- 40mm nylon lifting strop harness with stainless steel D-ring
- Fire retardant neoprene construction
- Waterproof zip and MED/SOLAS approved reflective tape
- Withstands the impact of a jump into water from 4.5 m
- Prevents a typical wearer's core body temperature from dropping by more than 2 °C after six hours in calm water of 0-2 °C
- No lifejacket required

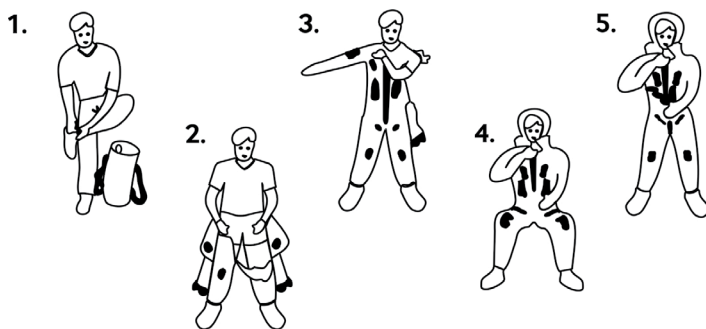

## Approvals

Approved in compliance with SOLAS 74/78 as amended Reg. 111/4, 111/7, 111/22, 111/32, 111/34, X/3. LSA Code I, II, as amended by MSC.207(81), MSC. 218(82). HSC Code 1994 MSC.36(63) and HSC Code 2000 MSC.97(73),8. IMO Resolution MSC.81(70), MSC, 226(82), MSC.323(89), MSC. Circ.1046



## Ordering Information

Product Number	Product Name
8808-M	Crew Endurance 140N Immersion Suit and Approved Light - Medium*
8808-L	Crew Endurance 140N Immersion Suit and Approved Light - Large*
8808-XL	Crew Endurance 140N Immersion Suit and Approved Light - Extra Large*

## Accessories

Product Number	Product Name
10226	Crewsaver Surface Light Unpackaged*

## TECHNICAL DATA

Newtons	140N
Size	
Medium	150 - 170 cm
Large	170 - 190 cm
Extra Large	190 - 210 cm
Harness	Lifting strop
Type	Immersion Suit

# CREW ENDURANCE PLUS

- 40 mm nylon lifting strop harness with stainless steel D-ring
- 5 finger integral latex glove for increased dexterity
- Additional over glove for increased insulation, can be stowed in its own sleeve pocket
- Unpacked and donned in under 2 minutes
- Fire retardant neoprene construction
- Waterproof zip and MED/SOLAS approved reflective tape
- Withstands the impact of a jump into water from 4.5 m
- Prevents a typical wearer's core body temperature from dropping by more than 2 °C after six hours in calm water of 0-2 °C
- Must be worn with a lifejacket

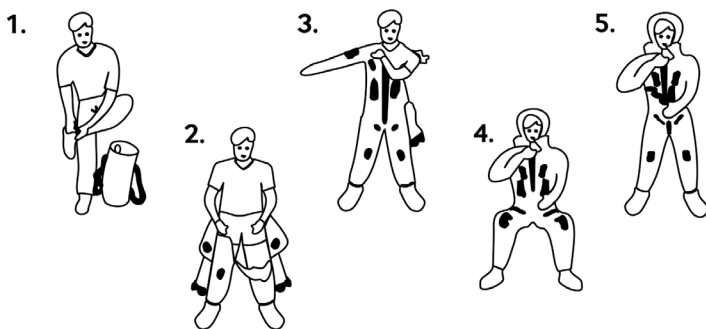

## Approvals

Approved in compliance with SOLAS 74, as amended, Regulations III/4, 34, 356 and X/3. The LSA Code Regulations I/1.2 and II/2.3. IMO Resolution MSC 81(70), Part 1 as amended by resolution MSC.226(82). Conforms to MSC207(81) when worn with an approved lifejacket



## Ordering Information

Product Number	Product Name
8800MK2-SHM	Crew Endurance Plus Immersion Suit - Medium
8800MK2-SHU	Crew Endurance Plus Immersion Suit - Universal
8800MK2-SHXL	Crew Endurance Plus Immersion Suit - Extra Large

## Accessories

Product Number	Product Name
1143-AUTO	**Seacrewsader 275N Twin Chamber Automatic with Hood*
10226	Crewsaver Surface Light Unpackaged*

\*\* A number of SOLAS lifejacket options are also available

## TECHNICAL DATA

Size	
Medium	150 - 170 cm
Universal	170 - 190 cm
Extra Large	190 - 210 cm
Harness	Lifting strop
Type	Immersion Suit

# CREW CHILD IMMERSION SUIT

- 50 mm nylon lifting strop harness with stainless steel D-ring
- Unpacked and donned in under 2 minutes
- 5 mm 3 finger neoprene gloves, hood and boots
- Fire retardant neoprene construction
- Waterproof zip and MED/SOLAS approved reflective tape
- Prevents a typical wearer's core body temperature from dropping by more than 2°C after six hours in calm water of 0-2°C
- Must be worn with a lifejacket

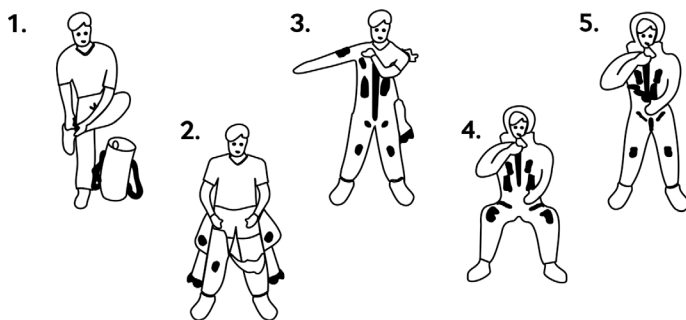

## Ordering Information

Product Number	Product Name
8800-SC	Crewsaver Child Immersion Suit
8800-SHC	Crewsaver Child Immersion Suit with Harness
8800-SCOT	Crewsaver Immersion Suit with Scot Buoyancy Unit

## Accessories

Product Number	Product Name
10226	Crewsaver Surface Light Unpackaged*

## TECHNICAL DATA

Newtons	140N
Size	110-150 cm
Harness	Lifting strop
Type	Immersion Suit
Approval	MED/SOLAS

## Approvals

Approved in compliance with SOLAS 74, as amended, Regulations III/4, 34, 356 and X/3. The LSA Code Regulations I/1.2 and II/2.3. IMO Resolution MSC 81(70), Part 1 as amended by resolution MSC.226(82). Conforms to MSC207(81) when worn with an approved lifejacket



# IMMERSION SUIT TEST KIT

- Designed to inflate immersion suit by external air compressor to inspect air tightness
- Ensures longevity of the users immersion suit through regular testing
- Compact and portable
- Best practices will ensure product quality is maintained and product is fit for use when needed in case of emergency
- Allows the user to inspect for leakages in the suit



## Ordering information

Product Number	Product Name
778930	Crewsaver Immersion Suit MK2 Test Kit*

# ACCESSORIES

## UNIVERSAL LIGHT

- Activates on contact with water or manually
- Flashing LED light
- Minimum 8hrs light duration

### Approvals

Approved in compliance with SOLAS 74, as amended, Regulations III/4, 34, 356 and X/3. The LSA Code



### TECHNICAL DATA

Light Output Vertical/Horizontal	Min 0.75 cd Max 6.0 cd
Light Output Surface Mount	8.0 cd
Light Duration	Min 8 hr
Light Type	Flashing LED
Material	PCTG/ABS/Silicone
Storage Temperature	-30 °C to +65 °C
Operating Temperature	-1 °C to +30 °C
Storage Life	5 Years
Activation	Water or Manual
Battery Type	Lithium Manganese Dioxide
Weight	49.4 g (Light Only)
Approvals	MED/SOLAS & USCG

### Ordering Information

Product Number	Product Name
10281	Universal Light Solas and Surface Mount Bracket
10282	Universal Light Solas and Circular Recessed Adaptors
10276	Universal Light Solas with Recessed Mount Bracket and Integrated Sensor*
10278	Universal Light Solas with Surface Mount Bracket and Integrated Sensor*

### Spares

Product Number	Product Name
10269	Universal Circular Recessed Housing



## LIFEJACKET SURFACE LIGHT

- High powered white LED lifejacket light
- Flashing for optimum visibility at sea
- Minimum light intensity 1.3cd at 0° (req. 0.75cd)
- Optimum output levels exceeds 3cd

### TECHNICAL DATA

Light Duration	Min 16 hr
Light Type	Flashing LED
Material	PCTG/ABS
Storage Temperature	-30 °C to +65 °C
Operating Temperature	-1 °C to +30 °C
Storage Life	5 Years
Activation	Water or Manual
Dimensions LxWxH	45 x 31 x 39 mm
Battery Type	Duracell Lithium Manganese Dioxide
Approvals	MED/SOLAS & USCG



### Ordering Information

Product Number	Product Name
10220	Crewsaver Surface Light
10226	Crewsaver Surface Light Unpackaged*

### Approvals

Approved in compliance with IMO, SOLAS, MED, MCA and RORC requirements,





# CREWSAVER ALKALINE LIGHT (CAL)

- Alkaline powered for a greener alternative whilst reducing disposal and transportation costs
- Can be surface or recess mounted
- Low profile design
- Activates on contact with water or manually
- Flashing LED light
- SOLAS approved
- 5 year storage life



Approvals  
MED/SOLAS



## Ordering Information

Product Number	Product Name
10277	Crewsaver Alkaline Light (CAL)

## Lifejackets fitted with CAL

Product Number	Product Name
13610	Premier 2010 LJ Adult + CAL Surface mounted
13611	Premier 2010 LJ Adult + CAL Recessed
13612	Premier 2010 Crew + CAL Recessed
13616	Premier 2010 LJ Child + CAL Surface mounted
13617	Premier 2010 LJ Infant + CAL Surface mounted
13618	Premier 2010 LJ Crew + CAL Surface mounted
13668	Premier 2010 LJ Child + CAL Recessed
13669	Premier 2010 LJ Infant + CAL Recessed
13672	Premier Compact + CAL Recessed
13679	Premier Compact + CAL Surface mounted
13690	Premier Compact Crew + CAL Recessed
13691	Premier Compact Crew + CAL Surface mounted

## Accessories

Product Number	Product Name
11271	Surface Mount Clip for CAL
11272	Circular Recessed Housing for CAL

## TECHNICAL DATA

Light Output	Minimum 8 Hours
Light Type	Lumiled LED
Material	PCTG/ABS/Silicone
Storage Temperature	-30 °C to 65 °C
Optimum Operating Temperature	0 °C to 45 °C
Activation	Automatic water activation with switch for manual operation
Battery Type	AAA Alkaline
Storage Life	5 years
Maintenance	Periodic check of operation

# PERRYBUOY

- Fitted with MED approved high intensity retro reflective tape
- Grabline made with a braid of high density polyethylene 10 mm diameter

## Benefits

- 4kg Perrybuoy – This weight of lifebuoy must be used to operate the self activated smoke signal and self igniting light from it's bracket on the bridge wing
- 2.5kg Perrybuoy – Can be used for all other positions on the vessel
- Both Perrybuoys can be stored in lifebuoy cabinets or stowed in the galvanised inverted Y brackets shown below



## Approvals

Approved in compliance with MED



## Ordering Information

Product Number	Product Name
751017	30" inch 2.5 kg Perrybuoy
751027	30" inch 4 kg Perrybuoy

## TECHNICAL DATA

Outer Diameter	751 mm +/- 2%
Inner Diameter	450 mm +/- 2%
Elliptical Section	Major axis 150 +/- 7 mm Minor axis 99 +/- 7 mm
Maximum Installation Height	60 m
Approval	MED/SOLAS

# LIFEBUOY Y BRACKET

- Galvanised coating for long life
- Galvanised Steel Y Bracket for 30" lifebuoys can be mounted anywhere where quick access to a lifebuoy is required
- Can be supplied with fixing plate for lifebuoy lights or manoverboard smoke and light units (special order)



## Ordering Information

Product Number	Product Name
735985	Y Bracket For Lifebuoy

# FLOATING LIFE LINE 30 METER

- Heaving lines supplied in 8 mm orange floating line to meet the SOLAS regulations
- Bespoke lengths available to suit specific applications
- Special heaving lines can be manufactured in line dispensers for offshore applications



## Ordering Information

Product Number	Product Name
606208	Floating Life Line 30 m

# LIFEBUOY SYSTEM MK2 ELECTRONIC REMOTE RELEASE

- GRP holder with metal spring holder and manual backup
- Hammar ERRS remote activation package
- ERU (electric remote unit) with cord pre-installed on metal holder
- Release switch
- Connector box
- 20m cable from connector box to release switch, screened 2 x 0.75 mm<sup>2</sup>, diameter 8 mm
- Manual safety pin
- Pilot line for loading the lifebuoy
- Installation manual
- User Guide
- Marking instruction
- Not supplied in the kit: Lifebuoy, mounting bolts for the installation onboard



## Ordering Information

PRODUCTS	
Product Number	Product Name
758989	Lifebuoy System MK2 Electronic Remote Release

# L170 LIFEBUOY LIGHT

- MED/SOLAS approved
- Commercial and Leisure versions available
- Five year life, no maintenance required
- Compact size, small and light
- Suitable for use on platform or vessel
- Drop tested to 76 metres

## Approvals

Approved in compliance with SOLAS/MED



## TECHNICAL DATA

<b>Battery Type</b>	Lithium Ion
<b>Drop Height</b>	76 m
<b>Battery Life</b>	Maximum 5 year life

## Ordering Information

Product Number	Product Name
FLL170C	L170 Lifebuoy Light

# DANIAMANT L160 LIFEBUOY LIGHT

- MED/SOLAS approved
- No maintenance or replacement batteries are required
- Compact and lightweight size
- Easy fitting

## Benefits

- 76 metre drop height, exceeding SOLAS requirement



## TECHNICAL DATA

<b>Output</b>	Min 2Cd
<b>Duration</b>	Min 2 hours
<b>Light Type</b>	Flashing LED
<b>Storage Temperature</b>	-30 °C to + 65 °C
<b>Operating Temperature</b>	-1 °C to + 30 °C
<b>Drop Height</b>	76 m
<b>Storage Life</b>	5 Years
<b>Weight</b>	255 g
<b>Activation</b>	Automatic via Pull Cord

## Ordering Information

Product Number	Product Name
777805	Daniamant L160 Lifebuoy Light MED

## Approvals

Approved in compliance with MED



# DANIAMANT L161 LIFEBUOY LIGHT

- MED/SOLAS and ATEX/IECEX approved
- ETL listed

## Benefits

- Intrinsically safe, for use in ALL potentially explosive zones
- No maintenance or replacement batteries are required
- Compact size, easy fitting
- 76 metre drop height, exceeding SOLAS requirement

## TECHNICAL DATA

<b>Output</b>	Min 2Cd
<b>Duration</b>	Min 2 hours
<b>Light Type</b>	Flashing LED
<b>Storage Temperature</b>	-30 °C to + 65 °C
<b>Operating Temperature</b>	-1 °C to + 30 °C
<b>Drop Height</b>	76 m
<b>Storage Life</b>	5 Years
<b>Weight</b>	300 g
<b>Activation</b>	Automatic via Pull Cord

# DANIAMANT L162 LIFEBUOY LIGHT

- USCG/MED/SOLAS approved
- NSN: 6230-99-613-4941
- No maintenance or replacement batteries are required
- Compact size
- Easy fitting

## Benefits

- 76 metre drop height, exceeding SOLAS requirement
- New L16X bracket makes it simple for you to replace older L40/L41B/L120 lights
- With the addition of non Hazardous batteries you can ship it around the world as it is exempt from Class 9 transport requirements

## TECHNICAL DATA

<b>Output</b>	Min 2Cd
<b>Duration</b>	Min 15 hours
<b>Light Type</b>	Flashing LED
<b>Storage Temperature</b>	-30 °C to + 65 °C
<b>Operating Temperature</b>	-1 °C to + 30 °C
<b>Drop Height</b>	76 m
<b>Storage Life</b>	5 Years
<b>Weight</b>	300 g
<b>Activation</b>	Automatic via Pull Cord



## Ordering Information

Product Number	Product Name
768408	Daniamant L161 Lifebuoy Light

## Approvals

Approved in compliance with MED



## Ordering Information

Product Number	Product Name
777803	Daniamant L162 Lifebuoy Light

## Approvals

Approved in compliance with MED



# DANIAMANT L163 LIFEBOUY LIGHT

- USCG/MED/SOLAS approved
- Drop tested to 76 metres
- TEX/IECEX approved
- ETL Listed

## Benefits

- Suitable for use in Hazardous Zones 0,1,2
- Exempt from Class 9 Transport Requirements

### TECHNICAL DATA

<b>Output</b>	Min 2Cd
<b>Duration</b>	Min 15 hours
<b>Light Type</b>	Flashing LED
<b>Storage Temperature</b>	-30 °C to + 65 °C
<b>Operating Temperature</b>	-1 °C to + 30 °C
<b>Drop Height</b>	76 m
<b>Storage Life</b>	5 Years
<b>Weight</b>	320 g
<b>Activation</b>	Automatic via Pull Cord



## Ordering Information

Product Number	Product Name
777802	Daniamant L163 Lifebuoy Light

## Approvals

Approved in compliance with MED



# LIFEBOUY LIGHT L90

- Robust and reliable
- Automatically activated after release from the bracket
- Supplied complete with a 1m lanyard
- Can be supplied with or without alkaline batteries
- MED/SOLA approved

## Approvals

Approved in compliance with MED



### TECHNICAL DATA

<b>Output</b>	Min 2Cd
<b>Duration</b>	Min 2 hours
<b>Light Type</b>	Filament Lamp
<b>Storage Temperature</b>	-30 °C to + 65 °C
<b>Operating Temperature</b>	-1 °C to + 30 °C
<b>Drop Height</b>	60 m
<b>Storage Life</b>	5 Years
<b>Weight</b>	1250 g
<b>Activation</b>	Self-activating via a tilt switch

## Ordering Information

Product Number	Product Name
576702	Lifebuoy Light L90

## Accessories

Product Number	Product Name
L38688	L90 Lamp
L38689	L90 O-Ring

# LIFEBUOY LIGHT ADAPTER PLATES

- Plate and all fixings
- No need to drill new holes
- Simply use the old holes and install your new lifebuoy light



## Ordering Information

Product Number	Product Name
777801	Daniamant Lifebuoy Light L16X Adapter Plate

# REFLECTIVE SAFETY TAPE

- Permanently marked with ship's wheel logo for immediate compliance identification
- Single layer construction for durability, abrasion resistance and flexibility
- No risk of water penetration
- FD1404 for use on inflatable devices, inflatable lifejackets, immersion suits
- FD1403 for use on devices and equipment with rigid substrates (ie steel, aluminium), Lifebuoys, Buoyant Apparatus



## Approvals

Approved in compliance with SOLAS/MED



## TECHNICAL DATA

Roll Length	45.7 m
Roll Width	50 mm
Type	Microprismatic

## Ordering Information

Product Number	Product Name
731493	FD1404 SA Retro Reflective Tape
731487	FD1403 SA Retro Reflective Tape

# CREWSAVER PRD

- High density delrin plastic rungs and steel rods
- Marine grade 316 stainless-steel snap hooks
- For use on Fast Rescue Craft
- Available in a variety of sizes
- Lifting strops and heaving lines included

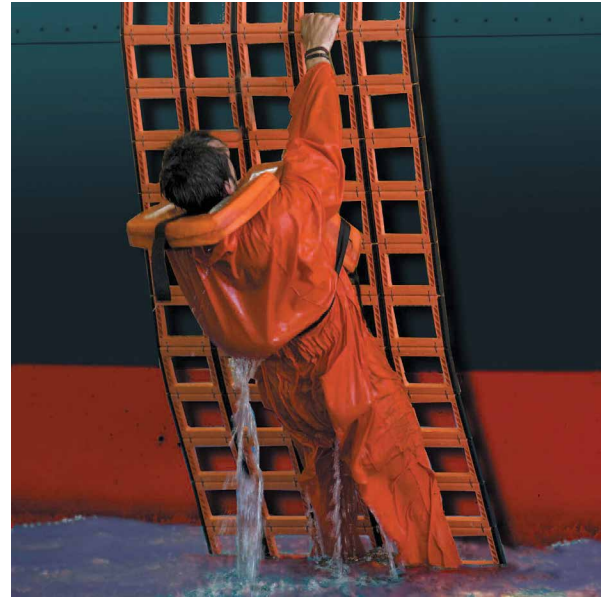

## Approvals

SOLAS, LSA Code Regulation I/1.2, IMO Resolution MSC.81 (70) Part 1 Section 1.2 & 1.4, SAE J 1960, ISO 4892-2

## Ordering Information

Product Number	Product Name
SEPRD314FRC	Crewsaver PRD 3 x 14 FRC
SEPRD415FRC	Crewsaver PRD 4 x 15 FRC

# MOB RECOVERY CRADLE

- SOLAS approved
- Lightweight and compact
- Portable and versatile design
- No requirement for annual servicing
- Carbon fibre rods enhance the strength with
- Loading's up to 900 kg per rung during tests



## Ordering Information

Product Number	Product Name
737014	Mob Recovery Cradle 2 m x 1.3 m
737016	Mob Recovery Cradle 3 m x 1.3 m
737018	Mob Recovery Cradle 4 m x 1.3 m
737020	Mob Recovery Cradle 5 m x 1.3 m

## Approvals/ Patents/ Certificates

SOLAS  
 UK Patent - GB2451127  
 EU Patent - 2178743  
 US Patent - 8905803  
 Certificate of Design Registration (IPO) -4028064  
 SOLAS Certificate Number - SAS S150121

## Accessories

Product Number	Product Name
737022	Mob Recovery Cradle Strops
TBC	Karabina for Attachment Strops
50463039	Extendable Pole and Hook

## TECHNICAL DATA

Width	1.3 m
Length	2 m - 7 m
Weight	1.6 kg per metre
Safe working load	900 kg



# EXTENDABLE POLE/HOOK

- Extendable pole & hook to assist with recovery



## Ordering Information

Product Number	Product Name
50463039	Extendable Pole/Hook for Recovery Cradle

# RESCUE STRETCHER KIT (MORS)

- Ergonomic, safe and effective stretcher
- Assists in the retrieval of casualties from the water
- High density plastic rungs and steel rods
- Marine Grade 316 stainless steel snap hooks.
- Includes lifting strops and heaving lines to aid a swift and practical retrieval.
- Available in two sizes, 9 x 8 and 11 x 10

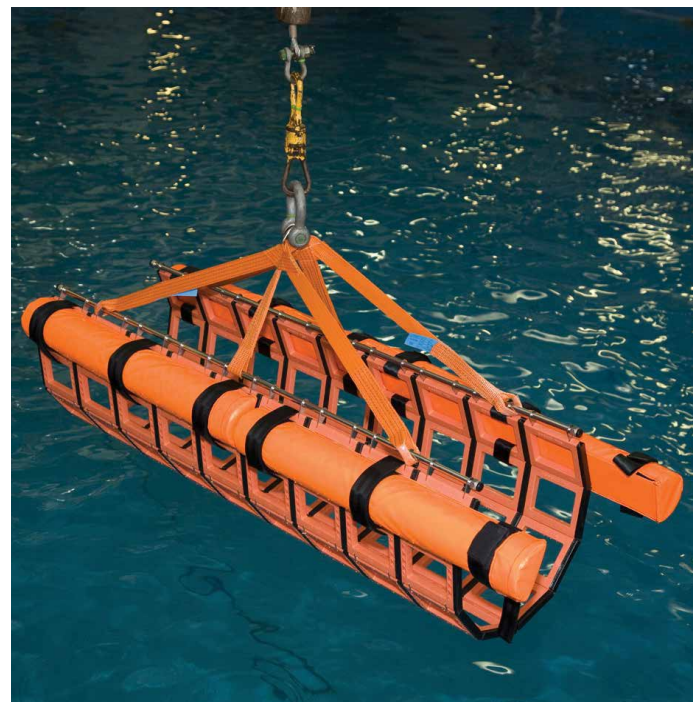

## Approvals

SOLAS LSA Code Regulation I/1.2, IMO Resolution MSC.81 (70) Part 1 Section 1.2 & 1.4, SAE J 1960, ISO 4892-2



## Ordering Information

Product Number	Product Name
SEPRDSK98	Crewsaver PRD Stretcher Kit 9 x 8
SEPRDSK1110	Crewsaver PRD Stretcher Kit 11 x 10

# FIBRELIGHT EMERGENCY LADDER

- Strong & durable
- Lightweight & compact
- Can be operated by a single person - the ladder can be rolled out and ready for use in less than a minute
- Can be loaded in both directions
- Standard width: 600 mm
- produced in lengths of 2 to 30 m
- Contains no metal parts - suitable for deployment on vessels and platforms with fire risks
- Double rung



## Ordering Information

Product Number	Product Name
LAFLEL10M	Fibrelight Emergency Ladder 10 m
LAFLEL30M	Fibrelight Emergency Ladder 30 m

# EMERGENCY LADDER CHEST

- Uniquely Lloyd's Register Type Test Approved
- 25 years' proven track record
- IP56 rated for excellent weather protection



## Ordering Information

Product Number	Product Name
LAPB10FELC	Emergency Ladder Chest

# PILOT LADDERS

- Designed for embarking or disembarking of pilots from the vessel
- MED approved
- Steps and spreaders made in one piece construction and free from knots and splinters
- Four lowest steps of a pilot ladder are made from rubber
- Type 'A' pilot ladder maximum length 9 m
- Type 'B' pilot ladder maximum length 36 m



## Ordering Information

Product Number	Product Name
LADPIL	Pilot Ladder

Approvals  
Approved in compliance MED



# EMBARKATION LADDERS

- Designed for safe embarkation of waterborne survival craft along a vertical portion of the ship's hull
- MED approved
- Maximum length 36 m



Approvals  
Approved in compliance MED



## Ordering Information

Product Number	Product Name
50463039	Embarkation Ladders

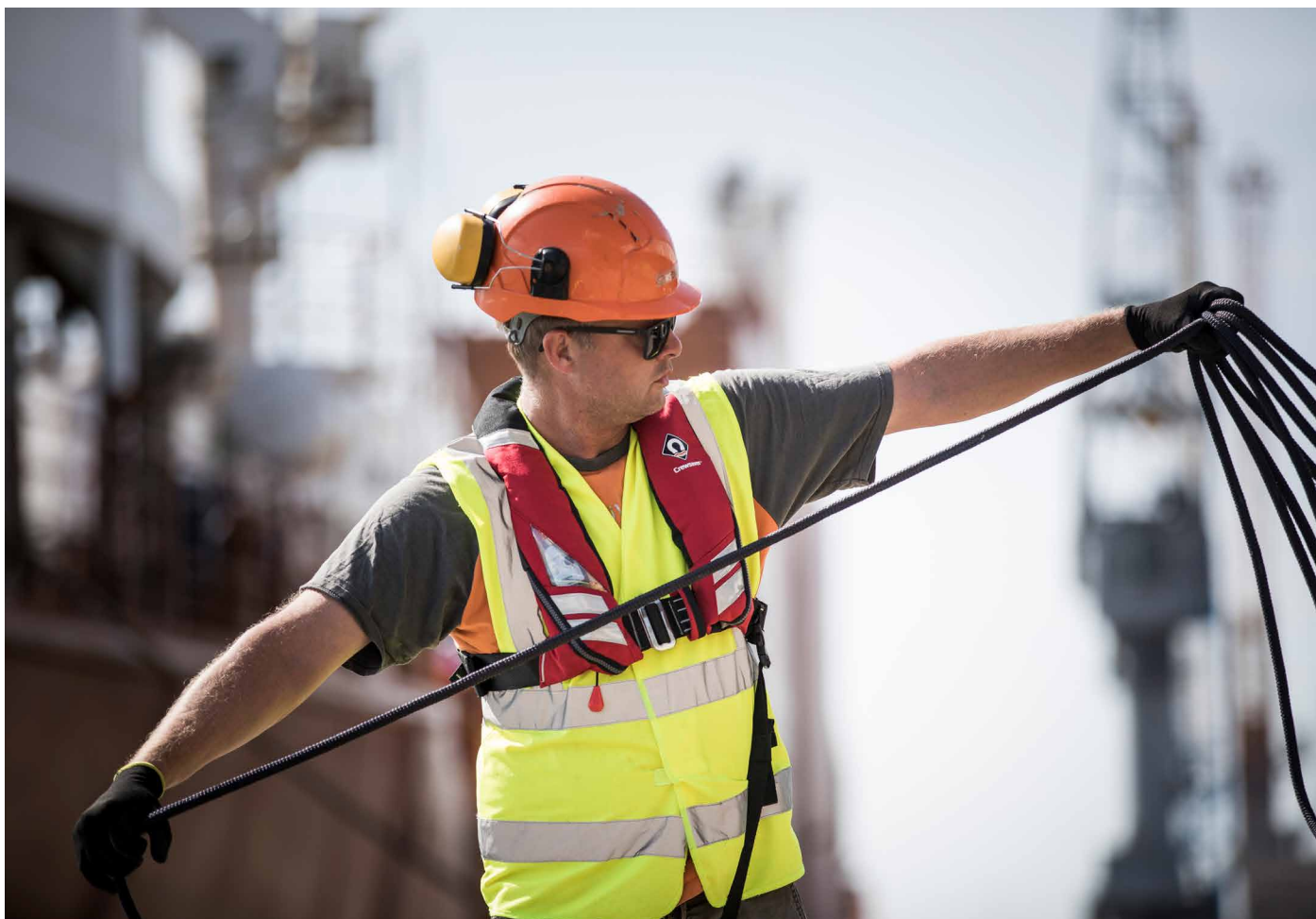

# LIFERAFTS

With over 160 years of technical expertise, Survitec is world-renowned for the design and manufacture of reliable and innovative liferaft solutions.

Within our portfolio we offer some of the most trusted brands available including; RFD, SurvitecZodiac and DSB. Every brand shares the same key focus; ensuring Survitec offer customers market longevity, quality and manufacturing excellence.

In addition we offer unmatched after-market solutions. We offer the largest service network across key ports and locations globally, helping to ensure efficient provision of your complete safety solution.



**Survitec offer customers market longevity, quality and manufacturing excellence**

# SURVITEC LIFERAFTS

- Fully enclosed double-skinned high-visibility canopy complete with retro-reflective tape
- Non-inflatable easy access boarding ramp
- High volume water pockets to ensure maximum stability when inflating
- Canopy fitted with LED light ensuring maximum visibility
- Fully insulated floor to ensure maximum thermal protection
- Stowed in lightweight, streamlined Glass Reinforced Plastic (GRP) containers enabling maximum deck space utilisation – various container options available
- Available with SOLAS 'A' and 'B' emergency pack configuration
- Sizes 12-25 also available as davit launch options
- Grey and black container colour options available on request



		LIFERAFTS PURCHASED BY BRAND			LIFERAFT RENTAL	
		Product Number			Product Number	
Type of Raft	Product Description	RFD (12 month service)	DSB (12 month service)	Zodiac (12 month service)	Extended Service Rental (ESR) (30 month service)	Liferaft Rental Exchange (LRE) (12 month service)
Throw Over Board (TOB)	6P TOB Liferaft	00008359	00008489	Z1560S-36	759306	759092
Throw Over Board (TOB)	8P TOB Liferaft	00009400	00009427	Z1562S-36	-	-
Throw Over Board (TOB)	10P TOB Liferaft	00100064201	00010420	Z1564S-36	759310	759118
Throw Over Board (TOB)	12P TOB Liferaft	00100064301	00011578	Z31182S-36	759312	759126
Throw Over Board (TOB)	16P TOB Liferaft	00041565	00041496	Z1568S-36	759316	759134
Throw Over Board (TOB)	20P TOB Liferaft	00012644	00012631	Z1570S-36	759320	759142
Throw Over Board (TOB)	25P TOB Liferaft	00013763	00013685	Z1572S-36	759325	759159
Throw Over Board (TOB)	35P TOB Liferaft	00086015	-	Z31388-36*	On Request	On Request
Davit Launch (DL)	8P DL Liferaft	-	-	Z31326-36	-	-
Davit Launch (DL)	12P DL Liferaft	00200064401	00011579	Z1574S-36	759322	759167
Davit Launch (DL)	16P DL Liferaft	00200064101	00041492	Z1576S-36	759326	759175
Davit Launch (DL)	20P DL Liferaft	00012645	00012623	Z1578S-36	759330	759183
Davit Launch (DL)	25P DL Liferaft	00013710	00013677	Z1580S-36	759335	759191
Davit Launch (DL)	35P DL Liferaft	00086004**	-	Z1584-36*	On Request	On Request

\* 37 Person

\*\* Max stowage 25 mtrs

## Approvals

Approved in compliance with SOLAS/MED



**liferaft davits are available for purchase.**

Please see page 131 for more information.

# LIFERAFT RENTAL

## Simple, hassle free process

At Survitec, we understand the importance of effective, operational practices when your vessel is in port. Our rental and exchange concept launched in 2008 changed the liferaft market forever. Today more than 8,200 vessels have Survitec rented rafts on-board. Renting rafts, rather than owning, is now the preferred solution on-board many vessels!

## Extended service liferaft (ESR)

When a 12 monthly service option simply will not suit your operational requirements, Survitec offers the ESR liferaft solution, extending your liferaft service intervals from 12 to 30 months. Then it is no longer required to facilitate a full service and exchange your liferaft annually. The ESR is hermetically sealed with humidity and CO<sub>2</sub> sensors, which allows the vessel crew members to carry out their own inspection regularly to ensure total working efficiency.

## Worldwide customer service

The Survitec dedicated global support function for all requests, logistics and invoice details means less coordination, administration and most importantly less risk of error.

With over 3,000 marine professionals covering 105 countries and more than 2,000 ports, Survitec is unrivalled with our worldwide customer support network.

## Convenient and cost effective

With a liferaft rental agreement you will experience several benefits for liferaft management. A key element of the Survitec concept is based on a single point of contact taking care of the due-date monitoring and arrangements for exchange of your liferafts.

- Predictable costs
- Reduced risk – avoiding replacement costs
- No investment required certificates
- No initial investments of rafts

## Always compliant, always on board

All our rental rafts are type and class approved, certificated and ready to use. Our teams around the world work hard to ensure your rafts are ready when and where they need to be. We will be waiting at your berth with your replacement rental rafts when you need, ready to go. We offer a variety of class approved, certificated and ready to use Survitec rafts:

- Option of Annual Liferafts (12 months) or Extended Service Liferafts (30 months) exchange
- Throw over and davit launch options
- 30, 60 or 90-day due-date notifications when your raft needs exchanging
- 6 – 35-man size options



## KEY BENEFITS OF EXCHANGE RENTAL

- Liferafts are replaced with a new approved set
- Comprehensive network, ensuring availability in all key ports world wide
- Supports short port stays
- Reduces the amount of handling required
- Less transportation required
- Offers a full guarantee for the duration of the rental period
- Highly skilled technicians, ensuring rafts are always in compliance with regulation

# LIFEBOATS AND RESCUE BOATS

Survitec supplies, inspects and maintains lifeboats, davits and LRRS hook release mechanisms to offshore, merchant shipping and cruise customers around the world.

Our experience and expertise are the foundations for our industry-leading services and products. Since 1991 we have grown our capabilities and our global network to support your safety objectives and IMO regulations. Our advanced design, manufacture, inspection and maintenance systems are in full compliance with the latest SOLAS regulations.



“

Keeping you compliant and safe to sail - a reputable and certified safety supplier

# LIFEBOAT RE-HOOKING

## LIFEBOAT RE-HOOKING IMO MSC.1 / CIRC.1392

### DEADLINE 1ST JULY 2019

#### Safelaunch (RocLoc) - the award winning lifeboat release and retrieval system

- The award-winning, IMO-compliant Safelaunch (RocLoc) release and retrieval system - designed, developed and manufactured by Survitec - features visual indicators, integrated fall prevention device (FPD), and more.
- Safelaunch (RocLoc) has been specifically designed so it can be easily retrofitted to any lifeboat or rescue boat.
- Featuring only the highest quality materials and manufacturing standards, Safelaunch (RocLoc) is reliable and robust – and requires minimum maintenance.
- Compliant with all latest SOLAS / LSA regulations for on load release systems and designed for use with any manufacturer's lifeboat design.
- Approved for use by DNV-GL, ABS, USGC BV & EC Type Examination and Transport Canada.
- Fully manufactured from Duplex and 316L Stainless steel including all steelwork and fasteners.

#### Cost effective replacement hook packages

- Our global installation teams can re-hook your lifeboats during dry dock or at a key port
- Turn key project management
- All approvals and documentation is handled by the Survitec project team
- IMO and EU approved and UK manufactured hooks available from stock
- Survitec can assess your fleet lifeboat LRRS compliance and offer a cost effective replacement hook package

#### Manufactured and stocked in the UK by Survitec and full approved by the following:



## THE CLOCK IS TICKING!

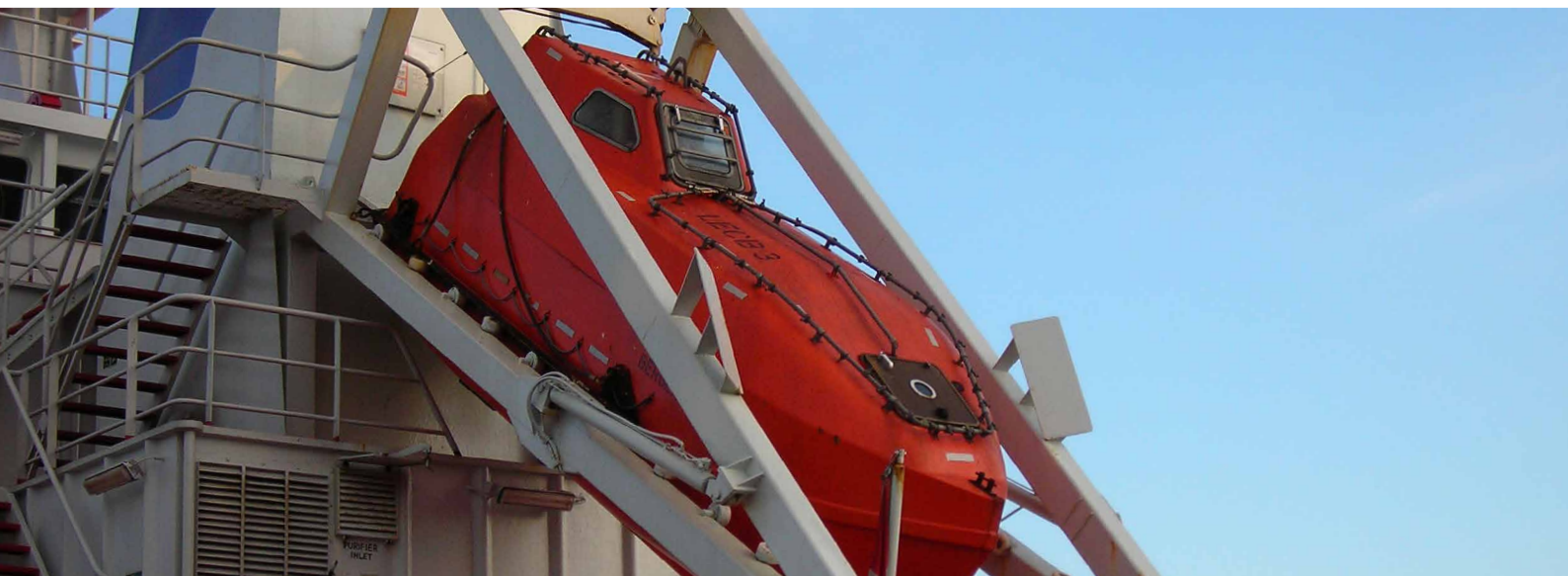



# LIFEBOATS

## TWIN FALL DAVIT-LAUNCH LIFEBOAT

- Capacities from 21 to 150 persons on board (POB)
- Seating for an average body of 82.5kgs (SOLAS requirement) to 98kgs (common offshore requirement)
- Tanker and dry cargo versions available
- Tanker versions include a compressed air supply to pressurise the lifeboat for a minimum of 10 minutes to prevent the ingress of smoke and an external water spray deluge system
- Buoyancy to self-right when fully loaded and in a damaged condition.
- Designed and built to latest IMO/SOLAS and LSA regulations
- Survitec can supply, commission, inspect and maintain our comprehensive range of twin fall davit launched lifeboats



### Approvals

IMO/SOLAS, LSA, ABS, BV, GL, LR AND EC



## FREE FALL LIFEBOAT

- Capacities from 24 to 95 persons on board (POB)
- Seating for an average body of 82.5 kg (SOLAS requirement) to 98 kg (common offshore requirement)
- Tanker and dry cargo versions available
- Tanker versions include a compressed air supply to pressurise the lifeboat for a minimum of 10 minutes to prevent the ingress of smoke and an external water spray deluge system
- Buoyancy to self-right when fully loaded and in a damaged condition.
- Suitable for offshore use: platforms, rigs FPSOs
- Designed and built to latest IMO/SOLAS and LSA regulations
- Survitec can supply, commission, inspect and maintain our comprehensive range of twin fall davit launched lifeboats



### Approvals

ABS, BV, GL, LR AND EC



# RESCUE BOATS

## RESCUE BOATS

- Inflatable or rigid versions available
- Rescue boats from DSB and SurvitecZodiac
- Lightweight material
- Small outboard engines ideally designed for smaller davits
- Easy transport, servicing and inspection
- Built for commercial marine and defence organisations
- Available in wooden or aluminium floor boards
- Inflatable deep V shaped keel for improved manoeuvrability
- RIBO 600 is equipped with self righting system suitable for use in difficult seas
- Rescue boat range includes varying sizes to suit multiple purposes and requirements
- Offer complete seaworthiness, shock mitigation and low freeboard.

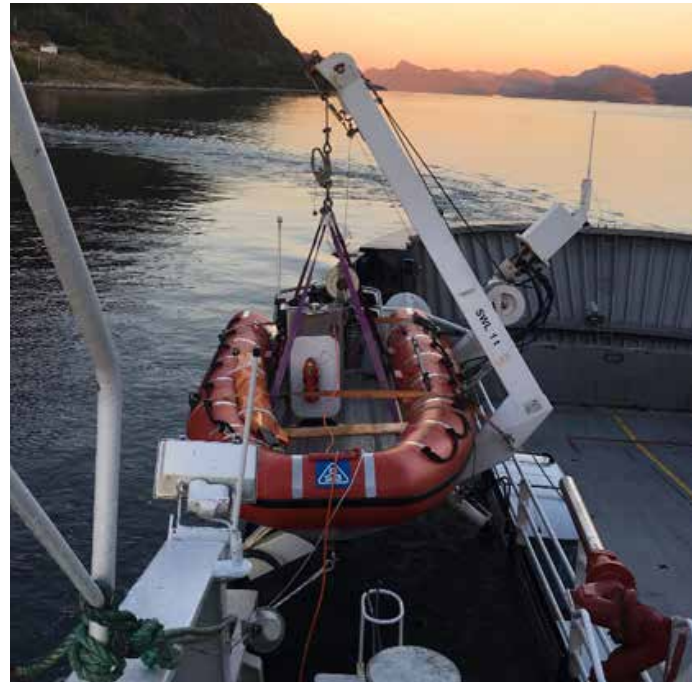

### Approvals

HSC code, LSA code, EC (MED), USCG, TC, RMRS



## FAST RESCUE BOATS

- Capacities from 6 to 15 persons on board (POB)
- Designed and built in accordance with the latest IMO, SOLAS, and LSA requirements for rescue craft
- Designed to be fast and manoeuvrable in all sea conditions
- Constructed from durable, long life, low maintenance materials producing an extremely high performance craft with superb handling characteristics
- Wide variety of intended applications, which includes Rescue, Patrol, Survey, Boarding, Customs, Diving and Inspection work
- High visibility orange hull and inner liner are manufactured from Fire Retardant Glass Fibre Reinforced Polyester
- The hull is a one-piece moulding. The laminated non-slip deck is self-draining
- Available with an outboard or diesel inboard engine with waterjet
- Fuel capacity sufficient for four hours operation



### Approvals

IMO/SOLAS AND LSA



**Rescue boat davits are available for purchase.**  
Please see pages **131** and **132** for more information.

# LIFERAFT AND RESCUE BOAT DAVITS

## PIONEERING DAVIT DESIGN SIMPLE INSTALLATION PHILOSOPHY.



survitec



SWL 10kN

## - THE NAME YOU CAN TRUST.

The Survitec range of davits are designed and manufactured by a European based manufacturing partner, whom hold over 20 years' experience supplying davits to the maritime market. Combined with Survitec' 160-year history provides customers decades of design and product knowledge in the industry.

Design has been the key to the success of these davits, not only is the Survitec range designed in accordance with the rules and regulations as published by the International Maritime Organisation (IMO), SOLAS & MED, they also included a standardised and smart design construction coupled with an efficient production and testing platform.

This combined with our simple installation setup where by the davit is supplied as a fully tested and assembled unit enables Survitec to offer faster turnaround times from order to delivery compared with the industry standard.

In addition, these new products hold several key features making them the top choice for customers operations and overall safety and longevity of the davit, including:

### FLAG AND CLASSIFICATION SOCIETY APPROVED

Survitec are the acknowledged leaders of both Flag State and Classification society approval standards, our comprehensive list of Class and Flag approvals qualifies us to inspect and service multiple brands of product and can therefore meet the requirements of the industry in their statutory responsibilities for service & inspection needs whatever your fleet. Furthermore, this is backed up by our Scottish Qualification Authority 'SQA' approved training school and ISO 9001:2015 accredited QA Management System.

Our extensive list of approvals includes:

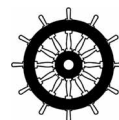

# LIFERAFT DAVITS - MANUAL

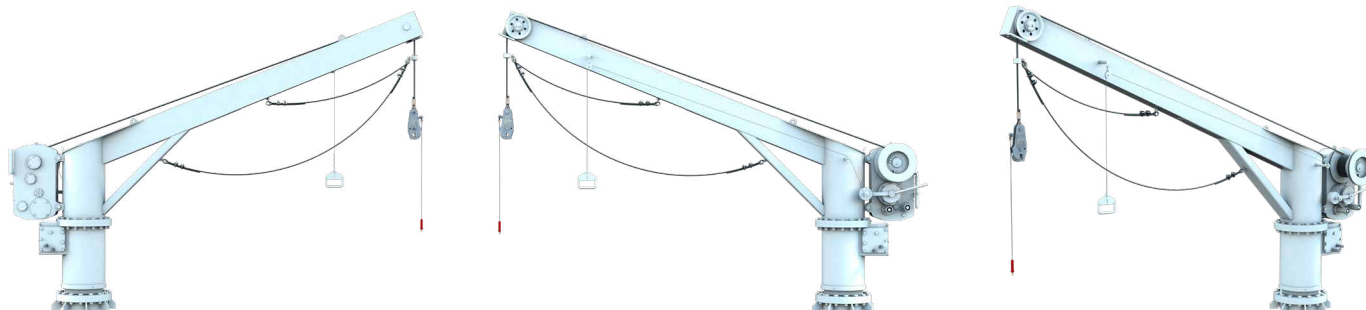

## TECHNICAL DATA

Certification:	<b>MED</b>
Rules and regulations:	<b>Latest IMO/SOLAS and LSA Code</b>
Certification authority (ICAS):	<b>Bureau Veritas</b>

## Ordering Information

Product Number	Product Name
Contact for info	Liferaft Davit Manual

# RESCUE BOAT DAVITS - HYDRAULIC

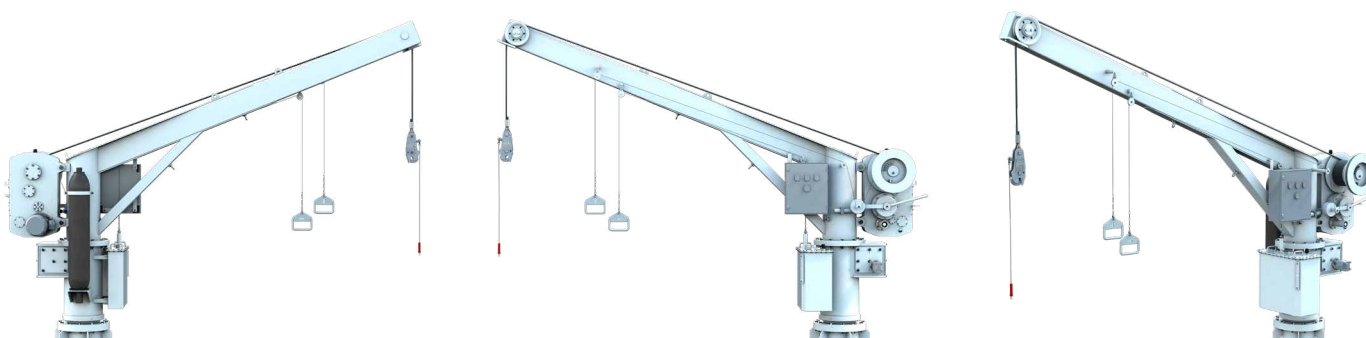

## TECHNICAL DATA

Certification:	<b>MED</b>
Rules and regulations:	<b>Latest IMO/SOLAS and LSA Code</b>
Certification authority (ICAS):	<b>Bureau Veritas</b>

## Ordering Information

Product Number	Product Name
Contact for info	Rescue Boat Davit - Hydraulic

# RESCUE BOAT DAVITS - MANUAL

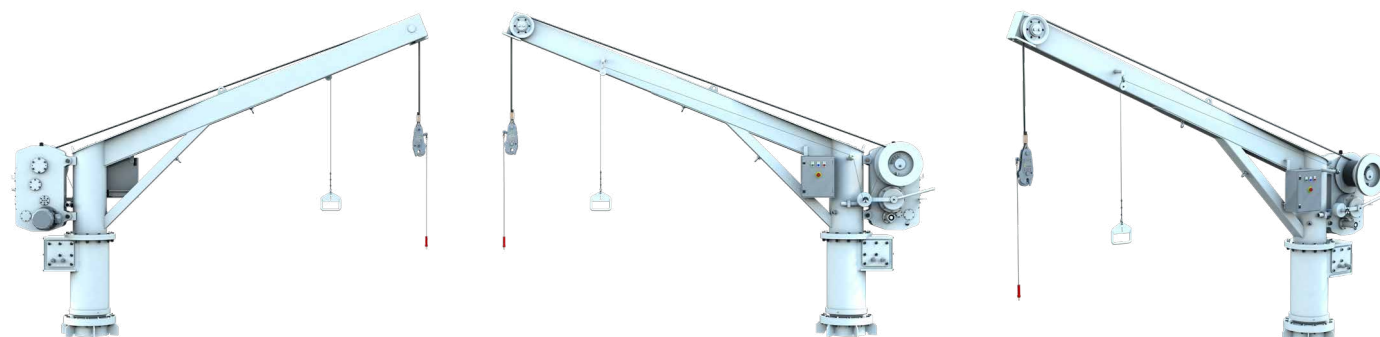

## TECHNICAL DATA

Certification:	<b>BV Type Approval</b>
Certification authority (ICAS):	<b>Bureau Veritas</b>

\*Operators are advised to obtain Flag State approval before purchasing a manual handling rescue boat davit

## Ordering Information

Product Number	Product Name
Contact for info	Rescu Boat Davit - Manual

# COMBI DAVITS - HYDRAULIC

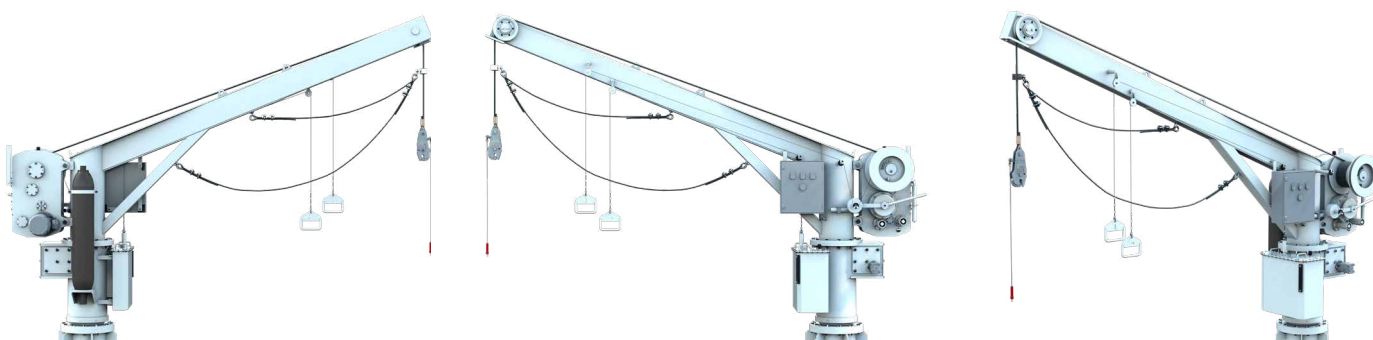

## TECHNICAL DATA

Certification:	<b>MED</b>
Rules and regulations:	<b>Latest IMO/SOLAS and LSA Code</b>
Certification authority (ICAS):	<b>Bureau Veritas</b>

## Ordering Information

Product Number	Product Name
Contact for info	Combi Davit - Hydraulic

# COMBI DAVITS - MANUAL

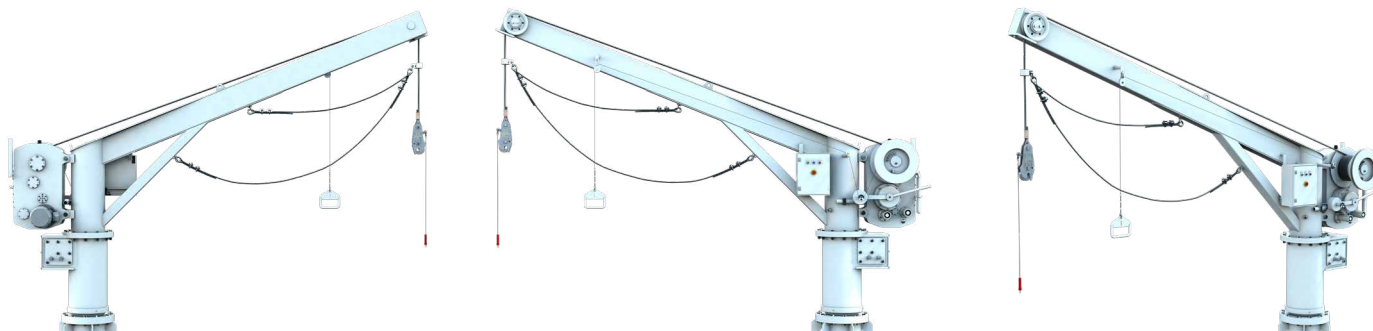

## TECHNICAL DATA

Certification:	<b>BV Type Approval</b>
Certification authority (ICAS):	<b>Bureau Veritas</b>

\*Operators are advised to obtain Flag State approval before purchasing a manual handling rescue boat davit

## Ordering Information

Product Number	Product Name
Contact for info	Combi Davit - Manual

# FAST RESCUE BOAT DAVIT

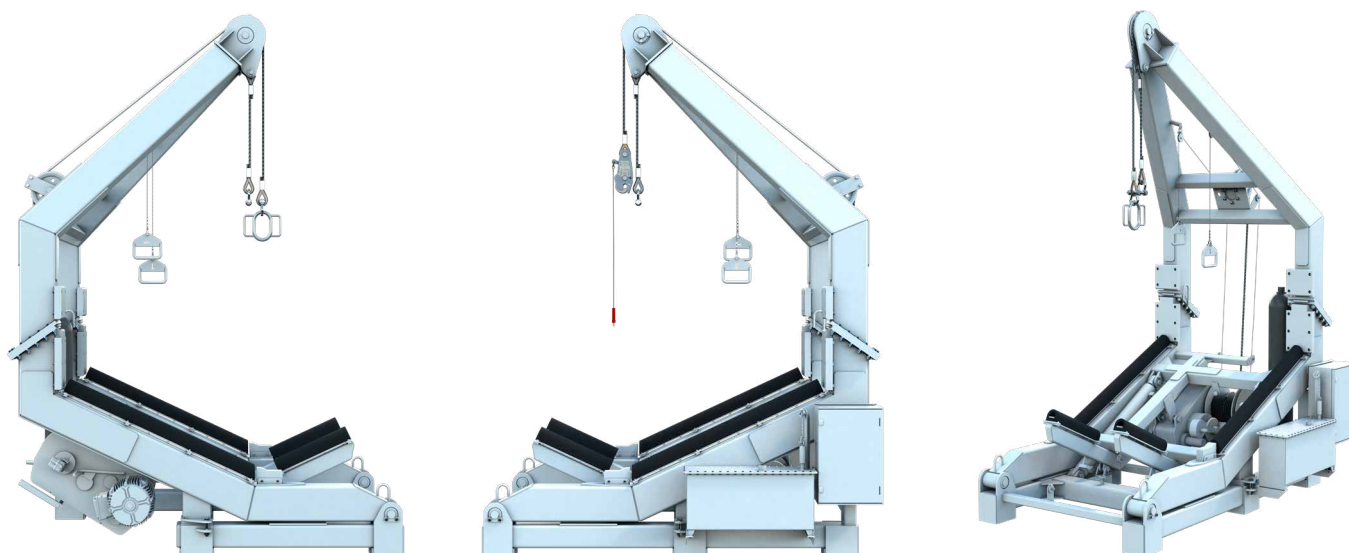

## TECHNICAL DATA

Certification:	<b>MED</b>
Rules and regulations:	<b>Latest IMO/SOLAS and LSA Code</b>
Certification authority (ICAS):	<b>Bureau Veritas</b>

## Ordering Information

Product Number	Product Name
Contact for info	Fast Rescue Boat Davit

# LIFEBOAT DAVITS

## LIFEBOAT DAVITS

- Range of ship and rig davit launching appliances for lifeboats
- Designed to withstand long periods of operation under adverse and extreme conditions in highly corrosive marine and offshore environments
- Meets IMO/SOLAS, LSA regulations as well as the European Council Directive 96/98 EC on Marine Equipment (M.E.D.)
- Standard and bespoke options available to meet individual vessel needs

### Options available

- Conventional gravity ship davit systems
- Freefall davits
- Fixed arm rig davits
- Fast rescue craft davits
- Slewing davits for combined liferaft / rescue boat
- Fixed Cantilever Launching Appliance
- Compact 'low head-room' hydraulic davit systems for FPSOs and ships and 'skid-mounted solutions'

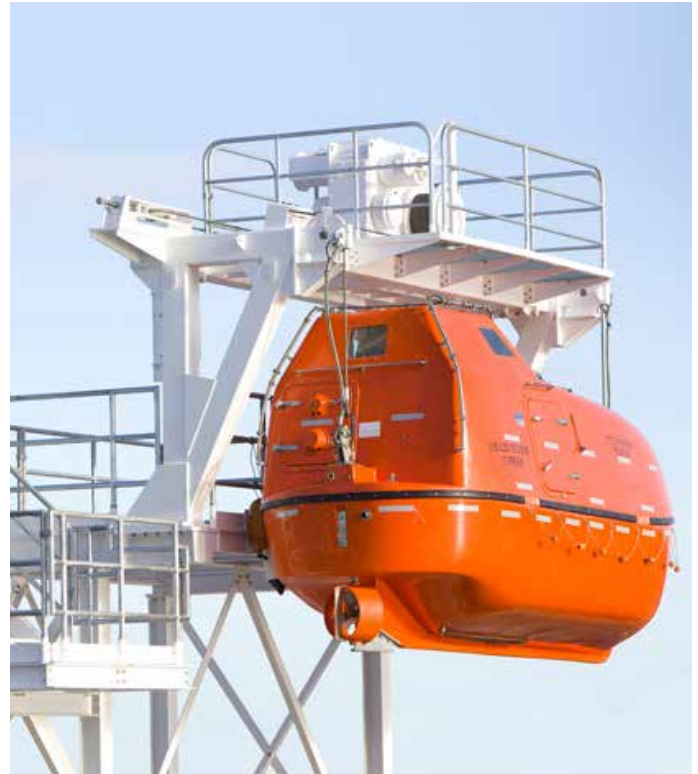

### Ship's Gravity Davit

#### TECHNICAL DATA

Model	Max. Working Load (kN)	Suitable Boat
SC60DL	60	SC50-60F/C
SC85DL	90	SC75F/C
SC138DL	138	SC85F/C - SC93F/C
SC170DL	180	SC95F/C
SC200DL	205	SC150F/C

### Ship's Gravity Davit Winch

#### TECHNICAL DATA

Model	Max. Working Load (kN)	Hositing Load (kN)	Lowering Load (kN)	
SC50DW	D50S Life	50	27	30
	D50Z Rescue	50	27	30
SC70DW	D70S Life	70	39	45
	D70Z Rescue	70	39	45
SCDW100	SCDW100 Life	100	70	60
	SCDW100 Rescue	100	55/70	60
SCDW130	SCDW130 Life	130	100	130
	SCDW130 Rescue	130	75/130	130
SCDW160	SCDW160 Life	160	160	160

*Our lifeboat davits are designed and manufactured by an alternative provider to our liferaft and rescue boat davits.*

## Platform/Rig Davit

### TECHNICAL DATA

Model	Max. Working Load (kN)	Suitable Boat
SC85DP	90	SC75F
SC/PL110	110	SC85F
SC138DP	140	SC85F - SC93F
SC185DP	185	SC95F
SC200DP	205	SC150F

## Platform/Rig Davit Winch

### TECHNICAL DATA

Model		Max. Working Load (kN)	Hositing Load (kN)	Lowering Load (kN)
SC/DW110	SC/DW110 Life	110	110	110
	SC/DW110 Rescue	110	60/110	110
SC/DW138	SC/DW138 Life	138	138	138
	SC/DW138 Life Rescue	138	80/138	138
SC/DW230	SC/DW230 Life	230	230	230

## A-Frame FRC Davit

### TECHNICAL DATA

Model	Max. Working Load (kN)	Suitable Boat
SCBEC2	19	SC60R
SC30DP	30	SC60R - SC70R
SC18/27DR	30	SC60R - SC70R

## Single Arm Rescue Boat/Liferaft Davit

### TECHNICAL DATA

Model	Max. Working Load (kN)	Suitable Boat
SC21DR Manual Liferaft Davit	21	Liferaft
SC23DR Rescue Boat/Raft Davit and Crane	23	SC40R - SC45R
SC30DR Rescue Boat/Raft Davit	30	SC60R - SC70R

## Single Arm Rescue Boat/Liferaft Davit Winch

### TECHNICAL DATA

Model	Max. Working Load (kN)	Hositing Load (kN)	Lowering Load (kN)
SC23DW	23	18	23
SC30DW	30	30	30



## Freefall Lifeboat Davit

### TECHNICAL DATA

Model	Max. Working Load (kN)	Suitable Boat
SC55DF	50	SC49FF/FC - SC59FF/FC
SC70DF	70	SC59FFA/FCA - SC67FF/FC
SC85DF	85	SC75FF/FC
SC100DF	110	SC90FF/FC - SC105FF/FC
SC230DF	230	SC120FF/FC - SC150FF/FC

## Ship's Roller Track Gravity Davit

### TECHNICAL DATA

Model	Max. Working Load (kN)	Suitable Boat
SC65DTL	68	SC50 - 60F/C
SC90DTL	90	SC75F/C
SC125DTL	125	SC85F/C - SC93F/C
SC160DTL	160	SC95F/C

## Ship's Hydraulic Gravity Davit

### TECHNICAL DATA

Model	Max. Working Load (kN)	Suitable Boat
SC130DYL	130	SC85F/C - SC93F/C
SC150DYL	160	SC95F/C
SC200DYL	205	SC150F/C

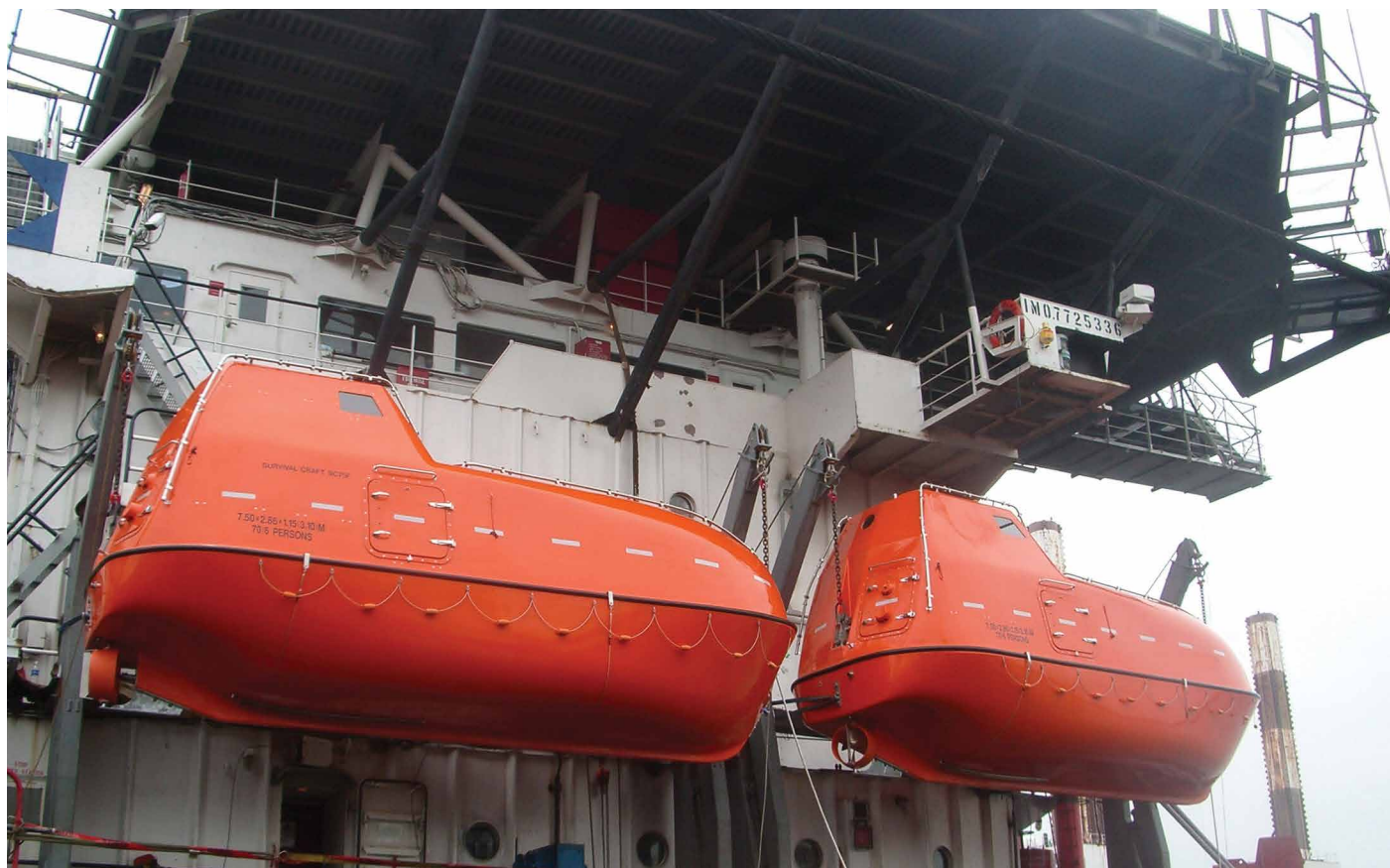

# LIFEBOAT, RESCUE BOAT AND LIFERAFT LRRS

## SAFELAUNCH HOOK SLA3.5

- The only hook on the market that can have the 5 year overhaul and test completed on board
- Colour coded visual indicators
- Load over-centre design
- 100% EU product, designed and manufactured in the UK by Survitec
- No service exchange requirement
- Single operating handle for ease of operation
- Two modes of operation; automatic and manual
- Safe working load of 3.5 tonnes
- Complies with SOLAS and LSA regulations

### Approvals

European Council Directive 96/98EC on Marine Equipment (MED) & United States Coast Guard.



### TECHNICAL DATA

<b>Model</b>	SLA3.5
<b>Type</b>	Davit-launched liferaft automatic release hook
<b>Application</b>	Fall-mounted for liferafts & rescue boats
<b>Approval</b>	MED & USCG
<b>Safe Working Load (SWL)</b>	3.5 tonne (35 kN)
<b>Static Proof Load</b>	8.75 tonne (87.5 kN)
<b>Dimensions (L x W x H)</b>	360 x 136 x 67 (mm)
<b>Weight (w / handgrip)</b>	7.0 kg

### Ordering Information

Product Code	Product Name
SLA-SP	Pin Spool
SLA-HL	Handgrip
SLA-ID	Operating Instructions
SLA-WR	Tether

# SAFELAUNCH LIFEBOAT RELEASE AND RETRIEVAL SYSTEM (LRRS)

- Safelaunch has been specifically designed so it can be easily retrofitted to any lifeboat and rescue boat
- Featuring only the highest quality materials and manufacturing standards, Safelaunch is reliable and robust – and requires minimum maintenance.
- Fully manufactured from Duplex and 316L Stainless steel including all steelwork and fasteners
- 100% EU Product. Designed and manufactured in the UK by Survitec using Marine Grade 316 corrosion-free stainless steel
- Includes type approval from DNV and Lloyd's Register, and has undergone a successful product design assessment from the American Bureau of ABS Shipping.
- Meets the latest requirements of SOLAS, IMO and LSA codes and is approved by DNV in accordance with the EU Marine Equipment Directive (MED).
- Crew and shore-based personnel training available



## Approvals

IMO/SOLAS, LSA, ABS, BV, GL, LR AND EC Type Examination and Transport Canada



## TECHNICAL DATA

<b>Model</b>	Safelaunch LRRS
<b>Type</b>	Onload LRRS Release Hook
<b>Application</b>	Twin Fall Davit Launched Lifeboats
<b>Approval</b>	MED/DNV/LR/ ABS & EU approved
<b>Safe Working Load (SWL)</b>	4.5, 6, 8.5 and 12 tonne options
<b>Material</b>	Duplex and 316L Stainless Steel
<b>Manufactured</b>	Survitec Aberdeen

## Ordering Information

Product Code	Product Name
RG-SL45-00001	4.5T Safelaunch Hook C/W Bushes
RG-SL45-00002	4.5T Safelaunch Hook Pin
RG-SL45-00003	4.5T Safelaunch Keeper Plate
RG-SL45-00004	4.5T Safelaunch Locking/Maintenance Pin
RG-SL45-00005	4.5T Safelaunch Operating Arm C/W Stickers
RG-SL45-00006	4.5T Safelaunch Operating Cam
RG-SL45-00007	4.5T Safelaunch Safety Gate
RG-SL45-00008	4.5T Safelaunch Transparent Hook Cover C/W Rubber (pair)
RG-SL60-00001	6.0T Safelaunch Hook C/W Bushes
RG-SL60-00002	6.0T Safelaunch Hook Pin
RG-SL60-00003	6.0T Safelaunch Keeper Plate
RG-SL60-00004	6.0T Safelaunch Locking/Maintenance Pin
RG-SL60-00005	6.0T Safelaunch Operating Arm C/W Stickers
RG-SL60-00006	6.0T Safelaunch Operating Cam
RG-SL60-00007	6.0T Safelaunch Safety Gate
RG-SL60-00008	6.0T Safelaunch Hook Bush

Product Code	Product Name
RG-SL85-00001	8.5T Safelaunch Hook C/W Bushes
RG-SL85-00002	8.5T Safelaunch Hook Pin
RG-SL85-00003	8.5T Safelaunch Keeper Plate
RG-SL85-00004	8.5T Safelaunch Locking/Maintenance Pin
RG-SL85-00005	8.5T Safelaunch Operating Arm C/W Stickers
RG-SL85-00007	8.5T Safelaunch Safety Gate
RG-SL85-00008	8.5T Safelaunch R-Pin
RG-SL85-00010	8.5T Safelaunch Cam Bushes
RG-SL-00012	Safelaunch Transparent Hook Cover C/W Rubber - 6.0T/8.5T

# LIFEBOAT ACCESSORIES

## LIFEBOAT AIR CYLINDER

- 50 litre filled cylinder
- 200 bar
- Standard fitting for many types of lifeboats
- Working pressure according to BS5045 / DOT3AA
- Lifeboat cylinder regulator Conforms to EN2503
- Clearly marked hand wheel displaying + or – for air pressure regulation
- Clear dials for cylinder pressure and flow rate



### Ordering Information

Product Number	Product Name
653386	L-50 AIR CYL.HWO VLV 200 BAR FILLED

### Spares

Product Number	Product Name
619221	REGULATOR R 510 FOR AIR
233494	CONNECTING STUB OX/N2/AIR

Approvals  
BS5045 / DOT3AA

## FALL PREVENTION DEVICE (FPD)

- Each FPD comes with a Lloyd's Register certificate as standard
- Each FPD is marked with the date it first came into service
- Includes label warning that the strop should not be used for any other purpose
- Manufactured from Ultra High Molecular Weight Polyethylene (UHMWPE) rope
- Exceptionally strong yet easy to handle by the ship's crew
- Offers excellent resistance to UV and chemical damage
- Supplied with an instruction manual
- Supplied with safety warning tag to attach to the release handle in the lifeboat to remind operators to remove the FPD before activating the lifeboat release mechanism
- Fully compliant with the MSC.1/Circ 1327 guidelines
- Can be retrofitted to all existing release and retrieval system



### Ordering Information

Product Number	Product Name
FRDYNFPD18/1.1M	Fall Prevention Device 1.1
FRTECFPD0.5M	Fall Prevention Device 0.5

Approvals  
Lloyd's Register



# LIFEBOAT EQUIPMENT

## Ordering Information

Product Number	Product Name
546663	Boat Hook, Aluminium Telescopic 2M
737160	Lifeboat Bailer
LRMANE/S	Lifeboat Survival Manual
LBAXE	Lifeboat Axe
LBCUPDR	Graduated Drinking Vessel
LBRAT.5	Food Ration 0.5 Kg Lifeboat/Raft
LBWAT.5S	Drinking Water 0.5 L Lifeboat/Raft
LBTORCOM	Torch Waterproof Signal with Batteries
764201	Signal Mirror / Heliograph
SETABSOL2	Lifesaving Signals Table - English
10678	Whistle Orange without Lanyard
LBFAK	Lifeboat First Aid Kit - Cat C Soft Pack
LBTABS/S	Anti Seasickness Tablets (60 Tablets)
LBBAGSS	Seasickness Bag
LBKNI	Lifeboat Jack Knife
764250	Rescue Quoit with Line
LBF/K	Lifeboat Fishing Kit
764210	Thermal Protective Aid
764211	Tin Openers
LBDIP	Lifeboat Dipper
LBPUMHDMKS	Manual Pump
LBTK	Lifeboat Tool Kit
IBSEARCH50W	Handheld Searchlight
LBCOM	Lifeboat Compass
LBRR	Radar Reflector
04503009	Floating Knife

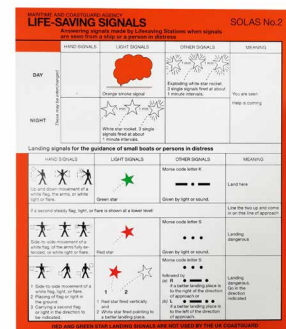

# LIFEBOAT INSPECTION

## ARE YOU COMPLIANT WITH SOLAS CHAPTER III?

SOLAS Chapter III stipulates the need for servicing, annual inspections and a thorough 5 year inspection and load testing of lifesaving appliances (LSA), launching arrangements and lifeboat release & retrieval systems (LRRS). Survitec responded to this approval requirement and offers an extensive inspection, servicing and maintenance programme available globally.

No matter what your requirements, merchant, cruise, ferry or offshore, Survitec Lifeboat inspection, repair and refurbishment services can help you keep fully compliant with existing regulatory requirements utilising our Global Safety and product network.



## WHY SURVITEC?

- Keeping you compliant and safe to sail - a reputable and certified safety supplier with over 25 years' lifeboat experience
- Flexible vessel and port arrangement with a growing team of over 100 service engineers available globally - if an engineer is not available at your local port we can send one to you
- Competitively priced
- Multibrand lifeboat service provider allowing us to carry out the work required for all your lifeboat types and brands
- Improve your operational efficiency – let Survitec service your complete safety portfolio including liferafts, fire systems and personal lifesaving equipment. Our cross-trained service engineers help to advance your operational efficiency
- Minimise the burden of administration – let Survitec handle your 'due date monitoring' process
- One point of contact for all of your requests, logistics and invoice details

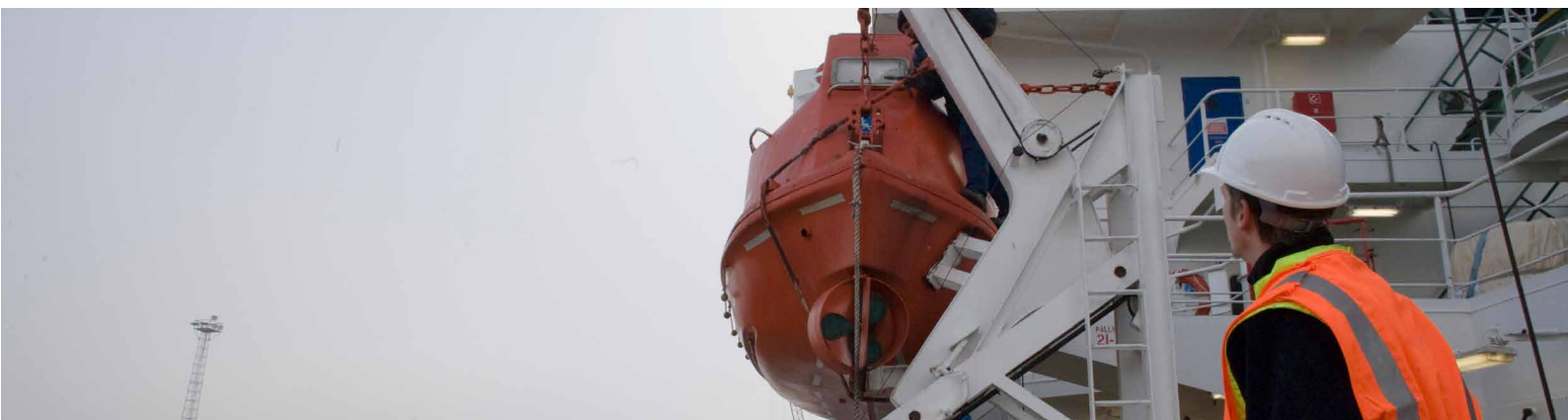

## KEY BENEFITS OF WORKING WITH SURVITEC

Survitec is now the world's largest maritime safety business, covering a vast range of safety products, services and systems. Having made significant company acquisitions since 2015, Survitec are now one of the world leading safety equipment manufacture for lifeboats covering initial supply, service, inspection, maintenance, testing and re-hooking requirements, all in accordance with the latest approval standards.

# LIFEBOAT SERVICES OFFERED



## LIFEBOAT INSPECTIONS

Using our well trained and experienced lifeboat engineers we are able to meet both your annual and 5-year inspection requirements. This includes overload testing, LRRS and launching appliance maintenance and overhaul, and a full range of new lifeboat and davit supply and commissioning. These activities are completed in accordance with SOLAS III and IMO requirements, under our Classification Societies and Flag States' approvals, assuring our customers we meet and surpass the statutory requirements.



## RE-HOOKING

In accordance with the latest re-hooking regulation update, MSC.1 / Circ. 1392, referencing lifeboat release hooks we are able to replace your lifeboat LRRS to ensure you are compliant with the new SOLAS approval standard (MSC.320 & 321(89)). Our Safelaunch and RocLoc hook replacement options are known for being robust, easy to maintain and unambiguous operation. As a class approved re-hooking service provider we can fit our hooks onto any lifeboat.



## SERVICE & MAINTENANCE

Survitec offers class leading capabilities in the preventative maintenance and overhaul of your lifeboat. Our service covers every aspect from the lifeboat itself, spare parts, refurbishments, LRRS and launching appliances. Our well trained and experienced service engineers are able to deliver these services aboard your vessel or within our conveniently positioned and equipped workshops.



## REFURBISHMENTS

We have a comprehensive refurbishment, repair and upgrade capability for lifeboats, davits and winches using our in house engineering facilities and experienced engineers. We carry out all design, drawing and Class submissions to offer you a complete package from inception to completion.



## SPARE PARTS

We can provide both original equipment manufacturer (OEM) and standard spare parts to suit your requirements as necessary.

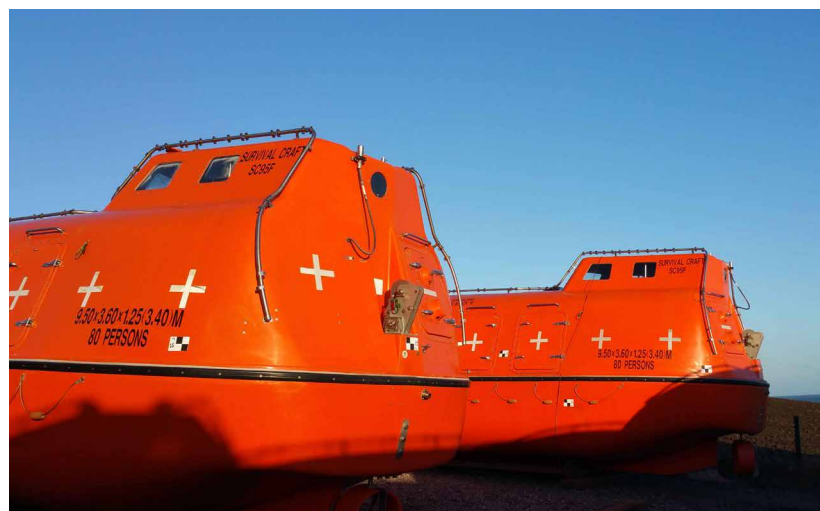

# EMERGENCY COMMUNICATION

Finding yourself in a distressful environment is not something any of us would like to incur. However, our diverse range of emergency communication can be a vital tool for attracting attention and communicating your intentions to other vessels. Our global distribution network supplies a range of quality approved brands to cater for a variety of vessel requirements and to suit your safety needs.



Vital tools to attract attention and communicating intentions



## LINETHROWER 250

- All line-throwing operations at sea between vessels, ship-to-shore, shore-to-ship and shore based rescue services
- Rescue of swimmers in distress
- Line carrying across obstacles and rough terrain
- SOLAS/MED and USCG compliant
- Throwing range of between 230 m and 250 m
- 9 year life

### TECHNICAL DATA

<b>Length</b>	330 mm
<b>Height</b>	315 mm
<b>Diameter</b>	205 mm
<b>Weight</b>	4.4 kg
<b>Net explosive content</b>	118 g
<b>Rocket Max Weight</b>	427 g
<b>Line Breaking Strain</b>	> 2 kn



### Ordering Information

Product Number	Product Name
790390	Linethrower 250 Unit

## LINETHROWER 250 ROCKET

- Self-contained line-throwing appliance consisting of a weatherproof plastic casing with end cap, twist-grip trigger assembly, rocket and line
- To comply with SOLAS requirements, four complete rocket and line assemblies should be carried on board
- Throwing range of between 230m and 250m
- A solid propellant is used which guarantees a highly accurate flight path even in strong side winds

### TECHNICAL DATA

<b>Dimensions</b>	37 x 27 x 27cm
<b>Weight</b>	9.4 kg
<b>Net explosive content</b>	118 g
<b>Hazard Class</b>	1.4 G



### Ordering Information

Product Number	Product Name
790762	Linethrower 250 Rocket

# MANOVERBOARD LIFEBOUY MARKER MK9

- Combined light and smoke manoverboard lifebuoy marker
- Mounts onto the ships bridge wing attached to a 4 kg lifebuoy
- Can be automatically or manually deployed
- Features a self-activated lighting system
- Safe to use on petrol and oil covered water

## TECHNICAL DATA

Height	375 mm
Diameter	183 mm
Weight	3.3 kg
Weight including brackets and angles	3.85 kg
Net explosive content	1.287 kg
Lamps	2 x 3.6 v 2.0 A
Temperature Range	-30 °C to +65 °C
Burning Time	15 minutes
Colour of light	White
Duration	2 candela for 2 hours



## Ordering Information

Product Number	Product Name
781595	Manoverboard Lifebuoy Marker MK9

# PARACHUTE RED ROCKET

- Approved to the latest worldwide SOLAS specification
- Performs reliably even after immersion in water
- Ejects a red flare on parachute at 300m (1000f)
- Burns for 40 seconds at 30,000 candela

## TECHNICAL DATA

Length	287 mm
Diameter	32 - 38 mm at handle
Weight	245 g
Net explosive content	92 g
Ignition	Pull Wire Ignitor
Flare Burning Time	40 seconds
Light intensity	30,000 cd
Colour of light	Red
Altitude	300 m



## Ordering Information

Product Number	Product Name
790758	Parachute Red Rocket MK8A

# RED HANDFLARE MK8

- Approved to the latest worldwide SOLAS specification
- Red hand held, short range distress signal used to pinpoint location by day or night
- Produces hot red flame for 60 seconds at 15,000 candela



## TECHNICAL DATA

Length	280 mm
Diameter	28 mm
Weight	176 g
Net explosive content	63 g
Ignition	Pull Wire Ignitor
Flare Burning Time	60 seconds
Light intensity	15,000 cd
Colour of Smoke	Orange

## Ordering Information

Product Number	Product Name
790754	Red Handflare MK8

# LIFESMOKE MK9 DISTRESS SIGNAL

- Signal for position marking during rescue operations
- Indicates wind direction
- Safe use on oil for petrol covered water
- Conforming to SOLAS 74/88
- Ideal also for leisure boat
- Compact unit ideally stored in a water-resistant locker at an ambient temperature



## TECHNICAL DATA

Height	144 mm
Diameter	82 mm
Weight	370 g
Net explosive content	239 g
Ignition	Percussion ignitor with 2 seconds delay
Burning Time	3 minutes minimum
Colour of Smoke	Orange

## Ordering Information

Product Number	Product Name
790760	Lifesmoke Distress Signal MK9

# CYALUME 6" SNAPLIGHT CHEMICAL LIGHT 15CM

- Easy to use
- Twist to activate – Bend/Snap and Shake
- Do not require a battery or rechargeable cell
- Packaging protects them from light and damp
- Maintenance free
- Phthalate free



## TECHNICAL DATA

<b>Packed Dimensions</b>	280 mm
<b>Packed Weight</b>	28 mm
<b>Product Dimensions</b>	176 g
<b>Weight</b>	63 g
<b>Capacity</b>	Pull Wire Ignitor
<b>Duration and Colour</b>	12 hours – Green, Red, Yellow, Orange 8 hours – Blue, White 30 minutes – Yellow, Red, White 5 minutes – HI Ultra Orange
<b>Shelf Life</b>	5 years – 6" SnapLight 12 hours and 8 hours 4 years – 6" SnapLight 30 minutes 2 years – 6" SnapLight Ultra Orange 5 mins

## Ordering Information

Product Number	Product Name
791681	Cyalume 6" Snaplight

# LIGHTSTATIONS MODEL 20, 4 & 10 EVACUATION BOXES

- Ideal for use on Cruise Ships
- Anti-break pins make it easy to check if the box has been opened
- Simple twist and shake activation
- Glow time of 4 hours
- Shelf Life 4 years



## Ordering Information

Product Number	Product Name
SULIGST20	Model 20 LightStation
SULIGST04	Model 4 LightStation
SULIGST10	Model 10 LightStation

## TRON 60S/GPS

- Small and compact design
- Tamper proof
- Optimal visibility
- High-intensity LED
- 5 years warranty
- The EPIRB can be supplied either with manual or float-free bracket

### TECHNICAL DATA

<b>Dimensions</b>	340 mm x 128 mm
<b>Weight</b>	680 g
<b>Battery</b>	Lithium metal, 12V/2900 mAh
<b>Service life</b>	5 years
<b>Materials</b>	Glass reinforced Polycarbonate
<b>Compass safe distance</b>	1 m
<b>Cospas-Sarsat Transmitter</b>	Frequency: 406.037 MHz Output power: 5W
<b>Homing transmitter</b>	Frequency: 121.500 MHz Output power: Up to 100 mW
<b>Protocols</b>	Maritime, Serialized, Radio Call sign
<b>Navigation device</b>	22 Channel GPS Receiver (Tron 60GPS)
<b>Antenna</b>	Omnidirectional
<b>Operating Life</b>	Minimum 48 hours at -20°C
<b>Temperature Range</b>	Operating: -20°C to +55°C (-4°F to +131°F) Storage: -30°C to +65°C (-22°F to +149°F)



### Ordering Information

Product Number	Product Name
83310	TRON 60S EPIRB with Floatfree Bracket
83320	TRON 60S EPIRB with Manual Bracket
83330	TRON 60GPS EPIRB with Floatfree Bracket
83340	TRON 60GPS EPIRB with Manual Bracket

### Spares

Product Number	Product Name
86218	TRON 60S/60GPS HRU Kit
86225	TRON 60GPS/60S Battery Kit

## SMARTFIND G8 AND G8 AIS EPIRB

- Rescue Accelerating features
- MEOSAR compatibility
- Easy service battery
- 10 year battery life
- Compliance with the new United States emergency hands free transport mandate
- False activation protection and self-test functions
- Rugged base

### TECHNICAL DATA

<b>Dimensions</b>	423 x 104 x 103 mm
<b>Weight</b>	710 g
<b>Length of Antenna</b>	206 mm
<b>Power Output</b>	100mW, 1W and 5W nominal
<b>Battery Type</b>	Lithium iron disulfide
<b>Operating Life</b>	48 hours minimum
<b>Shelf Life (in-service)</b>	10 years
<b>Temperature Range</b>	-30°C to +70°C storage -20°C to +55°C operational



### Ordering Information

Product Number	Product Name
731524	SmartFind G8 Auto EPIRB Floatfree
731523	SmartFind G8 Manual EPIRB
731527	SmartFind G8 AIS Auto EPIRB Floatfree
731527	SmartFind G8 AIS Manual EPIRB

# SMARTFIND E8 EPIRB

- Subscription Free
- Alerts global Search & Rescue professionals via Cospas Sarsat 406 MHz frequency
- Locates to within 3-5 km
- Uses 121.5 frequency to home into EPIRB location
- Water Activation
- 10 year battery
- Multiple false activation protection measures

## TECHNICAL DATA

<b>Dimensions</b>	423 x 104 x 103 mm
<b>Weight</b>	710 g
<b>Length of Antenna</b>	206 mm
<b>Power Output</b>	100mW, 1W and 5W nominal
<b>Battery Type</b>	Lithium iron disulfide
<b>Operating Life</b>	48 hours minimum
<b>Shelf life (in-service)</b>	10 years
<b>Temperature Range</b>	-30°C to +70°C storage -20°C to +55°C operational



## Ordering Information

Product Number	Product Name
731521	SmartFind E8 Auto EPIRB
731520	SmartFind E8 Manual EPIRB

# MCMURDO HRU REPLACEMENT KIT FOR E5/G5 EPIRB

- Should the vessel sink, the Hammar H20, which is activated by increasing water pressure, automatically release the EPIRB
- Use only manufacturer approved replacement bolt (rod)
- The Hammar H20 is made of glass fiber reinforced nylon, which means that it will not rust
- Needs no annual service, maintenance or spare parts
- Simply install a new one every two years and dispose of the old one
- Keeping the environment in mind, the old unit is 97% recyclable



## Ordering Information

Product Number	Product Name
COHRUHME	Cohruhme Hammar HRU EPIRB
COBLTHRU	Coblthru Breakable Rod Replacement Kit For EPIRB E5/G5

## TRON AIS-SART

### SEARCH AND RESCUE

- Adopted by IMO RES MSC. 256 (84) as an alternative to 9GHz SART
- Unique AIS technology contribute to a more effective and less time-consuming SAR operation, due to superior position accuracy
- The AIS-SART is detected on both AIS Class A and B
- Small and compact
- Jotron Tron AIS-SART use the same accessories as the Tron SART20 (Bulkhead bracket, pole, life-boat bracket and neoprene protection bag)
- 5 years warranty

#### TECHNICAL DATA

<b>Dimensions</b>	251 mm high
<b>Weight</b>	450 g
<b>Antenna Height</b>	Place at least 1m (3.3 ft) above sea/ground level
<b>Operating Life</b>	Minimum 96 hours
<b>Temperature Range</b>	Operating: -20°C to +55°C Storage: -30°C to +65°C

## TRON SART20

### RADAR TRANSPONDER

- Designed for use in search and rescue (SAR) operations
- Gives the location for any nearby vessel and aircraft with X-band radar
- Designed for use in lifeboats and liferafts
- Easy mounting in bulkhead bracket onboard the vessel
- Easy to release and activate
- 5 years warranty

#### TECHNICAL DATA

<b>Dimensions</b>	251 mm high
<b>Weight</b>	482 g
<b>Antenna</b>	Horizontal polarisation Omnidirectional radiation in the horizontal plane Greater than $\pm 2.5$ degrees elevation angle in the vertical plane
<b>Operating Life</b>	96 hours standby + 8 hours continuous operation when activated by a radar with 1 kHz prf at -20°C
<b>Temperature Range</b>	Operating: -20°C to +55°C Storage: -30°C to +65°C



#### Ordering Information

Product Number	Product Name
85037	TRON AIS-SART C/W Bulkhead BKT

#### Spares

Product Number	Product Name
82615	TRON SART 20 and AIS SART Battery



#### Ordering Information

Product Number	Product Name
83010	TRON SART 20 Radar Transponder

#### Spares

Product Number	Product Name
82615	TRON SART 20 and AIS SART Battery

# S4 RESCUE SART

- Ship or survival craft options
- Waterproof to 10m
- Compact and lightweight
- Replaceable 5 year battery pack
- Audio/visual indication of operation
- Built-in test facility
- Integral lanyard
- Mounting options - internal/external

## TECHNICAL DATA

<b>Dimensions</b>	264 mm x 90 mm
<b>Weight</b>	360 g
<b>Weight with Mast and Bracket</b>	530 g
<b>Effective Antenna Height</b>	1 meter or greater
<b>Radiated Power (ERP)</b>	400 mW (+26 dBm)
<b>Transmitter Response</b>	12 forward and return sweeps through range of 9.2 - 9.5 GHz
<b>Receiver Response</b>	9.2 - 9.5 GHz
<b>Battery Replacement</b>	5 years
<b>Duration</b>	96 hours in standby
<b>Temperature Range</b>	-30 °C to +65 °C storage -20 °C to +55 °C operational



## Ordering Information

Product Number	Product Name
731534	S4 Rescue SART

# TRON AIS-TR-8000 AUTOMATIC IDENTIFICATION SYSTEM CLASS A

- Separate display and transponder unit
- 7" Touch Screen Display
- Easy ECDIS interface
- Software upgradable
- Collision alarms (tCPA, CPA)
- Approved according to latest AIS-standard

## TECHNICAL DATA

<b>Dimensions</b>	
- Display Unit	210 mm x 83 mm x 150.4 mm
- Transponder Unit	319 mm x 204 mm x 77 mm
<b>Weight</b>	
- Display Unit	1 kg
- Transponder Unit	3.7 kg
<b>Temperature Range</b>	Operating: -20°C to +55°C Storage: -30°C to +65°C



## Ordering Information

Product Number	Product Name
85500	TR-8000 AIS Class A C/W GPS Antenna



# RADIOS

## TRON TR30 GMDSS AND MARITIME VHF RADIO

- Floating GMDSS and maritime VHF radio
- Full duplex channels accessed with rechargeable battery
- Emergency mode when connected to primary battery
- Excellent microphone noise cancelling
- Waterproof accessories



### Ordering Information

Product Number	Product Name
87950	TRON TR30 GMDSS & VHF Radio Kit
83446	TRON TR30 GMDSS VHF With Emergency Battery

### Spares

Product Number	Product Name
101035	TRON TR30 Emergency Lithium Battery
101036	TRON TR30 Rechargeable Battery

### TECHNICAL DATA

	Emergency battery (non-chargeable)	Rechargeable battery
<b>Frequency Range</b>	TX: 154-RX 161.875 MHz	TX: 154-RX:161.875 MHz
<b>Channel Spacing</b>	25 KHz	25 KHz
<b>Operating Temperature Range</b>	20°C to +55°C	20°C to +55°C
<b>Battery Operating Time</b>	12 h (10-10-80)	Typ. 12 h (5-5-90) medium
<b>Size</b>	61 mm x 157 mm x 40 mm (47 mm depth w/clip)	61 mm x 157 mm x 40 mm (47 mm depth w/clip)
<b>Full Buoyancy</b>	Yes	Yes
<b>Weight</b>	Approx.: 300 g	Approx.: 295 g

## R5 GMDSS VHF RADIO

- Waterproof to IP67 (submersible to 0.5 m for 30 minutes)
- MED (Wheelmark) and FCC approved
- Fully GMDSS compliant
- Rugged, drop tested construction with ribbed grip
- Large backlit display with battery indicator
- Rotary volume control
- Quick channel select button
- Keypad lock
- Dual and Tri Watch function
- Battery storage and charger base options



### TECHNICAL DATA

<b>Dimensions</b>	276 x 52 66 mm
<b>Weight</b>	340 g
<b>Waterproof Rating</b>	IP67
<b>Frequency Range</b>	149.3 - 174 MHz
<b>Channel Separation</b>	25 kHz
<b>GMDSS channels</b>	23
<b>Transmitter Power (Hi/L0)</b>	2/1 W
<b>Storage Temperature</b>	-30 °C to +70 °C
<b>Operating Temperature</b>	-20 °C to +55 °C

### Ordering Information

Product Number	Product Name
COVHFR5A	R5 VHF GMD SS - A Pack
COVHFR5B	R5 VHF GMD SS - B Pack

# E-TECH EP 400 UHF FIRE FIGHTER RADIO

- ATEX approved
- Compact size
- Power save mode capabilities
- Backlight LCD screen for ease of use
- Double conversion receiver
- Direct FM transmitter modulator
- Rugged hand-held grip
- Interface to external accessories

## 2018

On November 30, 2012 the Maritime Safety Committee adopted Resolution MSC.338(91) among which, Chapter II-2 "Construction – Fire Protection, Fire Detection and Fire Extinction" mentions specifically the use of suitable radio equipment.

### TECHNICAL DATA

<b>Dimensions</b>	114 x 55 x 30 mm
<b>Weight</b>	300 g
<b>IP Rating</b>	IP54
<b>Frequency Range</b>	UHF, 403 – 470 MHz
<b>Input Voltage</b>	7.4V DC
<b>Battery Type / Capacity</b>	Lithium-ion (Rechargeable), 1350 mAh
<b>ATEX Rating</b>	Class II 2G Ex ib IIC T4
<b>Marine Rating</b>	IEC 60945
<b>Operating Temperature</b>	-20 °C to +45 °C



### Ordering Information

Product Number	Product Name
SDK10 ATEX	EP-400 ATEX UHF Radio set, C-C440, HC-1, Leather Case
<b>B00197</b>	<b>EP-400 ATEX UHF Radio unit*</b>

### Accessories

Product Number	Product Name
B00569	EP-400 Savox C-C440 PTT unit
B00231	EP-400 Savox HC-1 Helmet unit
B00280	EP-400 Carry case unit
B00404	EP-400 APB8 Rechargeable Li-ion Battery unit

## IMO SIGNAGE

- Survitec can supply educational, operational and information posters
- Designed either as a training aid in compliance with the ISM Code, to inform of safe working practices or to fulfil the requirements of specific regulations
- Assists the ship owner/operator to fulfil their obligation by providing practical information on shipboard operations
- A number of posters are available in different languages to assist non-English speaking clients

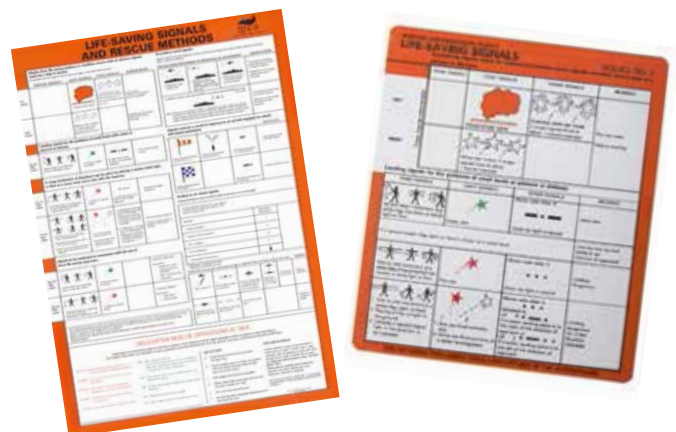

### Ordering Information

Product Number	Product Name
901982	Poster Lifesaving Signals – SOLAS 1
02176011	Lifesaving Signals Table – SOLAS 2

# FIRST AID AND MEDICAL

Many of your medical equipment needs are available through the Survitec portfolio; this includes a variety of first aid kits, defibrillators, eye wash stations, emergency showers and oxygen resuscitation equipment. Soft Packs first aid kits can be supplied for your lifeboat requirements and Hard Pack versions for your Small Passenger vessel requirements. Our entire range of products are specially designed for ease of use and is most importantly consistent reliability.



From basic care through to specialist casualty sustainment solutions.

# MEDICAL EQUIPMENT

## ZOLL AED PLUS

- Available in fully and semi-automatic versions
- Offers dependability, durability and continuous performance
- Real CPR help with voice and text prompts, and rate and depth feedback
- 12 second pre-shock pause
- Step-by-step directions
- Child specific algorithm
- 5-year stand-by battery life



### TECHNICAL DATA

<b>Waveform</b>	Rectilinear Biphasic
<b>Dimensions (H x D x W)</b>	13.3 x 24.1 x 29.2 cm
<b>Weight</b>	3.1 kg
<b>Electrodes</b>	CPR-D adult and CPR-D pedi
<b>Checks</b>	Manual
<b>Connectivity</b>	IrDA

### Ordering Information

Product Number	Product Name
FADFIBZAEDPSA	Zoll AED Plus Semi-Automatic Device
FADFIBZAEDPFA	Zoll AED Plus Fully Automatic Device

## ZOLL AED 3

- Available in fully and semi-automatic versions
- Dynamic rescue images and full colour display
- Universal pad design, offering a solution to treat both adult and pediatric victims of SCA using the same set of electro pads
- WiFi connectivity allowing for easy management of the users device via the cloud
- Real CPR help with voice and text prompts, and rate and depth feedback
- 8 second pre-shock pause
- Touch screen configuration
- Simple child mode activation
- 5-year smart battery stand-by life

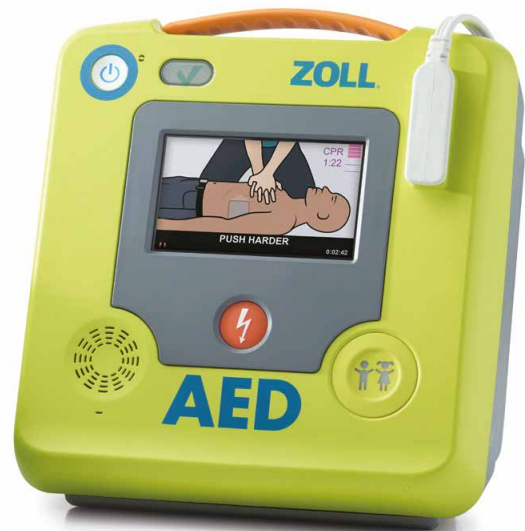

### TECHNICAL DATA

<b>Waveform</b>	Rectilinear Biphasic
<b>Dimensions (H x D x W)</b>	12.7 x 23.6 x 24.7 cm
<b>Weight</b>	2.5 kg
<b>Electrodes</b>	CPR Uni-padz
<b>Checks</b>	Automatic notification
<b>Connectivity</b>	WiFi

### Ordering Information

Product Number	Product Name
FADFIBZAED3SA	Zoll AED 3 Semi-Automatic Device
FADFIBZAED3FA	Zoll AED 3 Fully Automatic Device

# OXYGEN RESUSCITATOR WITHOUT CYLINDER

- Numerous sizes of guedel airways
- Manual ventilator with different sizes of oxygen masks
- Complete kit with bag
- Simple to use and requires no specialist training
- The user does not have to make judgements on the lung capacity of the patient to select a tidal volume, only the basic size or type of patient being cared for
- Fail-safe ensures proper use by venting excess gas whilst giving the operator an audible warning that the equipment is not being used correctly



## TECHNICAL DATA

Length	530 mm
Height	220 mm
Weight	5.1 kg

## Ordering Information

Product Number	Product Name
652131	Oxygen Resuscitator without Cylinder*



# IMO NORWEGIAN SOLUTION

- PiSS Valve (Pin Index safety system) connection as standard
- Complete system supplied in 1 box
- Complete installation instructions

## Benefits

- Easy installation
- Two separate flow meters allow for independent flow rates to each patient

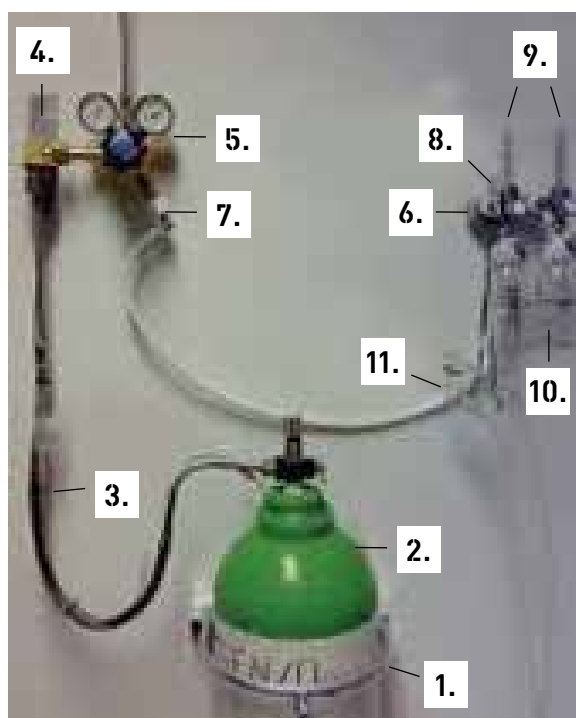

## Ordering Information

Product Number	Product Name
653295	Norwegian Medical Oxygen System IMO Excluding Cylinder

## Accessories

Product Number	Product Name	Position
320358	Rack for 1 Cylinder	1
-	On request Oxygen Cylinder	2
625038	High Pressure Oxygen Hose	3
596221	Adaptor with Bracket	4
<b>510021</b>	<b>Regulator 520 Oxygen Pressure 0 - 10 bar*</b>	<b>5</b>
608406	Double Outlet for Rail Mounting	6
653287	Quick Coupling Oxygen to G 3/8"	7
596403	Rail 1-Slit	8
596379	Flowmeter for Gas Outlet 0-12 L/min	9
596361	Humidifier 0.25 L	10
<b>610188</b>	<b>Oxygen Therapy Mask Disposable (10 Pack)*</b>	<b>11</b>
763581	Oxygen Medical Sign	N/A

## TECHNICAL DATA

<b>Dimensions</b>	350 x 350 x 550 mm
<b>Weight</b>	9.0 kg

## Approvals

IMO/MFAG approved



# OUTSIDE MED OXYGEN SYSTEM IMO

## WITHOUT CYLINDER

- PiSS Valve (Pin Index Safety System) connection
- Complete system supplied in one box
- Complete installation instructions

### Benefits

- Easy installation
- Two separate flow meters allow for independent flow rates to each patient
- MEDOX Cylinder on request

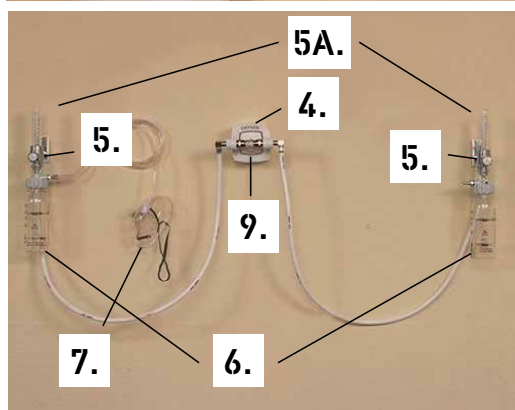
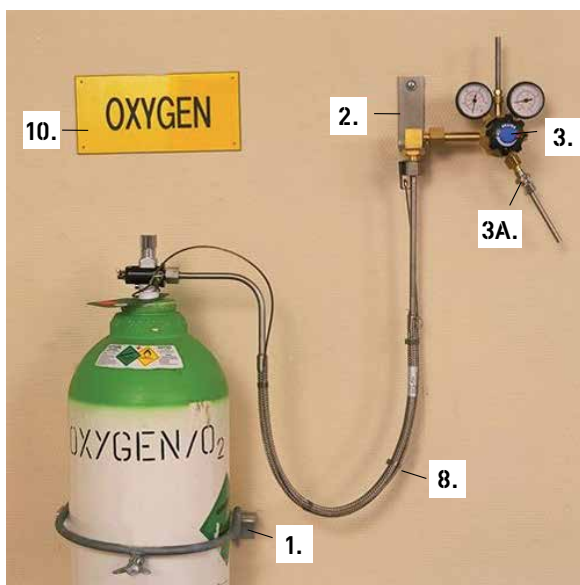

### Ordering Information

Product Number	Product Name
610253	Outside Med Oxygen system IMO

### Accessories

Product Number	Product Name	Position
320358	Rack for 1 Cylinder	1
596221	Adaptor with Bracket	2
510021	Regulator 520 Oxygen Pressure 0 - 10 bar	3
682435	Adaptor 8 mm >3/8" Bsp	3A
596445	Gas Outlet Mc 70 O <sup>2</sup>	4
596403	Rail 1-Slit	5
617886	Flowmeter for Rail Mounting 0-15 L/min	5A
596361	Humidifier 0.25 L	6
<b>610188</b>	<b>Oxygen Therapy Mask Disposable (10 Pack)*</b>	<b>7</b>
625038	High Pressure Oxygen Hose	8
606124	T-Piece with Oxygen	9
763581	Oxygen Medical Sign	10
638387	Cabinet for 1 IMO Medox Cylinder	N/A

### TECHNICAL DATA

Dimensions	350 x 350 x 550 mm
Weight	11.2 kg

### Approvals

IMO/MFAG approved



# BEDSIDE MED OXYGEN SYSTEM IMO

- PiSS Valve (Pin Index safety system) connection as standard
- Complete system supplied in 1 box
- Complete installation instructions
- MEDOX Cylinder on request

## Benefits

- Easy installation
- Two separate flow meters allow for independent flow rates to each patient

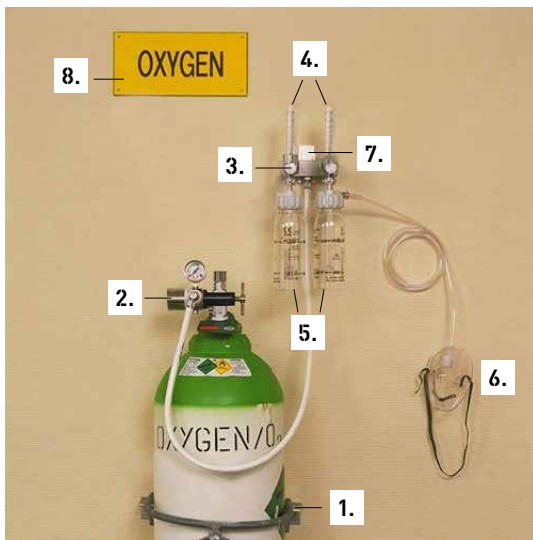

## Ordering Information

Product Number	Product Name
610261	Bedside Med Oxygen system IMO*

## Accessories

Product Number	Product Name	Position
320358	Rack for 1 Cylinder	1
608414	Regulator with quick coupling*	2
608406	Double outlet O2. for rail	3
596379	Flowmeter for gas outlet 0-15 litres per minute	4
596361	Humidifier 0.25 L	5
610188	Oxygen Therapy Mask Disposable (10 Pack)*	6
596403	Rail 1-slit	7
763581	Medical Oxygen Sign	8

## TECHNICAL DATA

Dimensions	350 x 350 x 550 mm
Weight	9.0 kg

## Approvals

IMO/MFAG approved





# STRETCHERS AND WATERJEL

## NEIL ROBERTSON STRETCHER

- Flexible semi-rigid canvas design
- Lightweight
- High quality materials for longer product life
- Can be neatly folded to store away
- No specialist training is required to use
- The strapping holds the casualty firmly even when you need to recover vertically
- For use in an instance where a casualty needs to be lowered or lifted to safety
- Strong neck and head restraint for stability on the move
- Durable, non-rot cotton and slat construction
- Includes support rope to enable lifting and lowering

### TECHNICAL DATA

<b>Length</b>	150 cm
<b>Width</b>	100 cm
<b>Weight</b>	10 kg
<b>Lifting Capacity</b>	120 kg

### Approvals

CE-marked according to the European directive for Medical Device 93/42/EEC and registered by the Swedish Medical Products Agency



### Ordering Information

Product Number	Product Name
184390	Neil Robertson Stretcher

This stretcher is not able to be supplied for delivery in the US due to US FDA regulations.

## FIRE BLANKET WATERJEL

- A full-size blanket that adequately covers a patient
- Can be used to extinguish flames and smouldering clothes
- Durable, easily identifiable canister
- Can be stored or used with WaterJel Mounting Bracket
- Size: 152cm x 182cm



### Ordering Information

Product Number	Product Name
FABLKTW/JC	Water-Jel Fire Blanket



# SERVICING & MAINTENANCE

MARINE EVACUATION SYSTEMS (MES), LIFERAFTS, LIFEJACKETS, LIFEBOATS, RESCUE BOATS, SURVIVAL SUITS & FIRE EQUIPMENT



With over 160 years' experience to our name, we ensure your equipment receives only the very best care and attention throughout its entire safety lifecycle.

We are the world leader in the supply, inspection, testing and maintenance of safety and survival equipment. Through our network of 500+ accredited service stations, we offer a truly global service covering over 2,000 ports worldwide. We have a renowned reputation for reliability of service and workmanship. Our work is always to the highest standard and our technical ability is continuously being upgraded with the latest equipment, facilities and training.

## LIFEBOAT INSPECTION

Using our well trained and experienced lifeboat engineers we are able to meet both your annual and 5-year inspection requirements. This includes overload testing, LRRS and launching appliance maintenance and overhaul, and a full range of new lifeboat and davit supply and commissioning. These activities are completed in accordance with SOLAS III and IMO requirements, under our Classification Societies and Flag States' approvals, assuring our customers we meet and surpass the statutory requirements.

See page 141 for more information.

## SERVICING CAPABILITY

- ✓ FULL SERVICING SOLUTIONS FOR MARINE EVACUATION SYSTEMS (MES), LIFERAFTS, LIFEJACKETS, LIFEBOATS, RESCUE BOATS, SURVIVAL SUITS & FIRE EQUIPMENT
- ✓ INFLATABLE TUBE AND GLASS FIBRE HULLS REPAIRS FOR RIBS AND RESCUE BOATS
- ✓ TESTING AND REFILLING OF GAS CYLINDERS & FIRE EQUIPMENT
- ✓ EACH SERVICE CERTIFICATE PRINTED WITH A UNIQUE CODE TO RECORD WHERE A SERVICE HAS BEEN CARRIED OUT

# SOLAS 360



**SAFETY ON BOARD YOUR VESSEL IS OF THE UTMOST IMPORTANCE. IN TODAY'S COMPETITIVE MARKET OPERATORS CONTINUE TO SEEK WAYS TO MAXIMISE THEIR EFFICIENCIES AND INCREASE VALUE WITHOUT COMPROMISING ON PERFORMANCE.**

As leader of the marine safety industry, Survitec has taken on the task to develop a solution that makes sure vessels are kept safe and compliant while reducing complexity and increasing value for the customer. Working in close cooperation with ship operators, managers and owners we asked how we could make operations easier and more efficient, from this SOLAS 360 was born.

SOLAS 360 is a brand-new, market-first concept with the aim of keeping vessels safe and compliant. Providing operators with an all-encompassing safety solution covering the totality of their safety equipment supply and servicing needs, including liferafts, lifeboat, fire systems and loose safety equipment.

Learn more about how we map and pro-actively manage services on all safety equipment, reduce risk and provide high quality products and services.

# Customer Service Team

---

## Customer Services - OSLO

---

Email: [nordic.cs.technicalservices@survitecgroup.com](mailto:nordic.cs.technicalservices@survitecgroup.com)  
Phone: + (47) 67 58 00 58

Customer Services Oslo serves customers located in Denmark, Finland, Iceland, Norway and Sweden

---

---

## Customer Services - SINGAPORE

---

Email: [singapore.cs.technicalservices@survitecgroup.com](mailto:singapore.cs.technicalservices@survitecgroup.com)  
Phone: +65 6395 4561

Customer Services Singapore serves customers located in Australia, Indonesia, Malaysia, Myanmar, New Zealand, Philippines, Singapore, Taiwan, Thailand and Vietnam.

---

---

## Customer Services - HAMBURG

---

Email: [germany.cs.technicalservices@survitecgroup.com](mailto:germany.cs.technicalservices@survitecgroup.com)  
Phone: +49 42 8259 39900

Customer Services Hamburg serves customers located in Austria and Germany.

---

---

## Customer Services - ROTTERDAM

---

Email: [netherlands.cs.technicalservices@survitecgroup.com](mailto:netherlands.cs.technicalservices@survitecgroup.com) Phone: +31 10 8009390

Customer Services Rotterdam serves customers located in Belgium, Luxembourg, Netherlands and Switzerland.

---

---

## Customer Services - HOUSTON

---

Email: [us.cs.technicalservices@survitecgroup.com](mailto:us.cs.technicalservices@survitecgroup.com)  
Phone: +1 832 753 5001

Customer Services Houston serves customers located in Bahamas, Canada, Mexico and the United States

---

---

## Customer Services - GENOA

---

Email: [sena.cs.technicalservices@survitecgroup.com](mailto:sena.cs.technicalservices@survitecgroup.com)  
Phone: +39 010 6142 111

Customer Services Genoa serves customers located in Algeria, Angola, Croatia, France, Italy, Liberia, Libya, Malta, Monaco, Montenegro, Morocco, Nigeria, Portugal, Slovenia, Spain and Tunisia.

---

---

## Customer Services - LONDON

---

Email: [uk.cs.technicalservices@survitecgroup.com](mailto:uk.cs.technicalservices@survitecgroup.com)  
Phone: +44 1322 282 990

Customer Services London serves customers located in Ireland and the United Kingdom.

---

---

## Customer Services - TOKYO

---

Email: [japan.cs.technicalservices@survitecgroup.com](mailto:japan.cs.technicalservices@survitecgroup.com)  
Phone: +81 3 6386 0176

Customer Services Tokyo serves customers located in Japan.

---

---

## Customer Services - HONG KONG

---

Email: [hongkong.cs.technicalservices@survitecgroup.com](mailto:hongkong.cs.technicalservices@survitecgroup.com)  
Phone: +852 9331 1764

Customer Services Hong Kong serves customers located in Hong Kong.

---

---

## Customer Services - SHANGHAI

---

Email: [china.cs.technicalservices@survitecgroup.com](mailto:china.cs.technicalservices@survitecgroup.com)  
Phone: +86 21 6086 3923

Customer Services Shanghai serves customers located in China.

---

---

## Customer Services - DUBAI

---

Email: [uae.cs.technicalservices@survitecgroup.com](mailto:uae.cs.technicalservices@survitecgroup.com)  
Phone: +971 4 382 3840

Customer Services Dubai serves customers located in Azerbaijan, Bahrain, Bangladesh, Bulgaria, Egypt, Ethiopia, India, Iraq, Jordan, Kazakhstan, Kenya, Kuwait, Namibia, Oman, Pakistan, Qatar, Romania, Saudi Arabia, South Africa, Sri Lanka, Tanzania, Turkey, Ukraine, United Arab Emirates and Yemen.

---

---

## Customer Services - BUSAN

---

Email: [korea.cs.technicalservices@survitecgroup.com](mailto:korea.cs.technicalservices@survitecgroup.com)  
Phone: +82 51 7204009

Customer Services Busan serves customers located in Korea.

---

---

## Customer Services - ATHENS

---

Email: [greece.cs.technicalservices@survitecgroup.com](mailto:greece.cs.technicalservices@survitecgroup.com)  
Phone: +30 216 900840

Customer Services Athens serves customers located in Albania and Greece.

---

---

## Customer Services - SZCZECIN

---

Email: [poland.cs.technicalservices@survitecgroup.com](mailto:poland.cs.technicalservices@survitecgroup.com)  
Phone: +48 91 4648 900

Customer Services Szczecin serves customers located in Estonia, Latvia, Lithuania, Poland and Russia.

---

---

## Customer Services - LIMASSOL

---

Email: [cyprus.cs.technicalservices@survitecgroup.com](mailto:cyprus.cs.technicalservices@survitecgroup.com)  
Phone: +357 25 751322

Customer Services Limassol serves customers located in Cyprus, Israel, Lebanon and Syria.

---

---

## Customer Services - RIO DE JANEIRO

---

Email: [brazil.cs.technicalservices@survitecgroup.com](mailto:brazil.cs.technicalservices@survitecgroup.com)  
Phone: +55 21 3031 1120

Customer Services Rio de Janeiro serves customers located in Argentina, Brazil, Chile, Cuba, Ecuador, Honduras, Panama, Peru, Uruguay and Venezuela.

---

survitec

# ONE SUPPLIER, ONE PROMISE



- SAFETY SERVICE SIMPLIFIED





## GET IN TOUCH

### **SURVITEC**

1-5 Beaufort Road, Birkenhead, CH41 1HQ, United Kingdom

**Email:** [info@survitecgroup.com](mailto:info@survitecgroup.com)

**[www.survitecgroup.com](http://www.survitecgroup.com)**

### **Copyright Notice**

The copyright, trademarks, domain names and other intellectual property rights in all material and information in this presentation belongs to Survitec Group Limited. All rights are reserved.

### **Disclaimer**

This document provides general information about Survitec Group and its companies, its products and services, and summarises general capabilities and offerings which we deem to be of relevance to our customers. Whilst Survitec has taken appropriate steps to ensure the accuracy of the information contained in this document, Survitec gives no warranty regarding the accuracy or completeness of such information.

This presentation was prepared to provide information and does not constitute a contract. Survitec reserves the right, without prior notice, to change, delete, supplement, or otherwise amend at any time the information, images, and offerings contained in this presentation, or other documents. Survitec shall not be liable for any loss or damage of whatever nature (whether direct, indirect, consequential or other) that may arise as a result of any third party relying on the information contained in this document (but nothing in this disclaimer excludes liability for death or personal injury arising from negligence or any fraudulent misrepresentation).

For further detailed information, prices, terms and conditions, customers should contact Survitec at [info@survitecgroup.com](mailto:info@survitecgroup.com)

Rv4